

Rockingham Planning Commission Regional Broadband Plan

December 2014



156 Water Street, Exeter, NH 03833
Tel. 603-778-0885 ♦ Fax: 603-778-9183
email@rpc-nh.org ♦ www.rpc-nh.org

- Atkinson • Brentwood •
- Danville • East Kingston •
- Epping • Exeter •
- Fremont • Greenland •
- Hampstead • Hampton •
- Hampton Falls • Kensington •
- Kingston • New Castle •
- Newfields • Newington •
- Newton • North Hampton •
- Plaistow • Portsmouth •
- Rye • Salem •
- Sandown • Seabrook •
- South Hampton • Stratham



The New Hampshire Broadband Mapping & Planning Program is funded under grant #33-50-M09048 from the US Dept. of Commerce to the University of New Hampshire.



Table of Contents

Acknowledgements.....	iv
A. Executive Summary	1
RPC Region Broadband Vision	1
RPC Regional Broadband Plan Recommendations	1
B. Introduction.....	2
1. Project Background.....	2
2. Program Components & Objectives.....	2
Mapping.....	2
Technical Assistance and Training	3
Capacity Building	3
3. Planning	4
4. Understanding Broadband.....	5
Broadband Explained	5
Levels of Broadband Service in New Hampshire Error! Bookmark not defined.	
How It Works	8
Why Broadband Is Important	11
Broadband Importance by Sector	13
C. Vision, Goals, and Objectives for Broadband in the Region.....	16
E. Existing Conditions	17
1. Regional Overview	17
Geography and Physical Landscape.....	17
Population Characteristics.....	18
Socioeconomic Conditions	18
Anticipated or Significant Demographic/Economic Trends	19
2. Regional Broadband Availability	19
History of Broadband Planning in the RPC Region.....	20
Results of Broadband Mapping	21
Map 1 - Broadband Availability at Community Anchor Institutions	22
Map 2 - Maximum Advertised Download Speed.....	23
Map 3 - Degree of Competition for Broadband Availability	24
Map 4 - Broadband Availability (Served, Underserved, Unserved).....	25
Map 5 - Availability of Fiber Optic Technology.....	26
Map 6 - Availability of Cable Modem Technology	28

Map 7 - Availability of DSL Technology	29
Map 8 - Speed Test Results	30
3. Regional Demand for Broadband	32
Results of the 2012 Statewide Survey	32
Results of the 2013 Survey of RPC Region	33
Results of NHBMPP Speed Test	34
RPC Sector Based Analysis	36
F. Challenges to and Opportunities for Regional Broadband Development	39
1. Barriers and Opportunities	39
Political/Regulatory Barriers.....	39
Economic Barriers	40
Social Barriers	40
Technological Barriers.....	41
2. State and Local Initiatives.....	42
G. Findings and Recommendations	43
1. Evaluation and prioritization of needs/challenges/opportunities	43
H. Implementation	45
1. Identification of Prioritized Strategies, and Actions, Timeframe and Responsible Parties	45
2. Implementation Matrix	50
J. Appendices/Resources	52
K. Glossary	57

Maps:

- Map 1 – Broadband Availability at Community Anchor Institutions
- Map 2 – Maximum Advertised Download Speed, Including Cellular, by Census Block
- Map 3 – Number of Broadband Providers, Including Cellular, by Census Block
- Map 4 – Broadband Availability by Census Block
- Map 5 – Interim Map of Fiber Availability
- Map 5A – Network New Hampshire Now Map
- Map 6 – Broadband Provided via Cable Modem
- Map 7 – Broadband Provided via DSL
- Map 8 – Speed Test Results by Provider

Acknowledgements

The RPC would like to thank the many people who have contributed their time to make this project successful. In particular we thank **Southwest Regional Planning Commission** for their organizational assistance and the New Hampshire Broadband Mapping and Planning Program (NHBMPP) managed by UNH GRANIT for their technical guidance throughout the project. We also thank the many contacts that assisted us in our RCAI survey. **Robert Morse** for providing historical context and background data.

Finally, we wish to express our sincere appreciation to the RPC Broadband Stakeholders Group who endured many long meetings and provided important feedback to the project over several years. Our BSG members are as follows:

Roger Barham – Town of Fremont

*Laurel Bistany – Regional Economic Development Center of So. New Hampshire,
Raymond, NH*

Lionel Dube – Riverwoods Continuing Care Community, Exeter

Robert Landman – Town of North Hampton

Mike Turell – Town of Atkinson

A. Executive Summary

Residents and visitors, municipalities and businesses, educational institutions and cultural organizations, and the health care industry in the Rockingham Planning Commission (RPC) region all consider broadband to be critical infrastructure. Reliable, high speed internet service is an essential tool for accomplishing tasks that make positive contributions to our regional economic health and social welfare. In a short period of time, access to broadband has changed the ways in which we manage both home and work.

In the RPC region, most sectors of the economy perceive broadband service to be adequate. However, lack of competition is seen as preventing consumer choice and creating high costs for service. Lack of information on the location and type of broadband service available is an obstacle to planning for service improvements.

The RPC's Regional Broadband Plan was developed by RPC staff with guidance from a Broadband Stakeholders Group comprised of representatives from the utility industry, municipal boards, community organizations, and an economic development agency. Their insight and knowledge about the current state of broadband, as well as invaluable knowledge about the history of internet development in the region, enabled the RPC to develop this Plan, establish a regional broadband vision, and create regional recommendations designed to increase the availability, adoption, affordability and performance of broadband.

RPC Region Broadband Vision

In today's interconnected, global economy, broadband is considered a critical infrastructure for both businesses and citizens. To enable municipalities, businesses, and residents to benefit from the economic, educational, and recreational opportunities provided by broadband access, the RPC envisions a region in which broadband is seen as critical infrastructure and maintaining and enhancing the capacity and adoption of broadband ensures the region thrives, adapts, and captures these opportunities.

RPC Regional Broadband Plan Recommendations

The following recommendations were given the status of "higher" priority by the RPC's Broadband Stakeholder's Group:

- Develop a service map for the region which includes proprietary information from private providers.
- Encourage competition among broadband providers.
- Include broadband in hazard mitigation and recovery/response planning.
- Include broadband service as part of negotiations between municipalities and service providers.
- Ensure ISP capacity planning is adequate to serve future needs.
- Ensure the broadband network is sufficiently resilient and redundant to serve in times of crisis.

- Promote the installation of broadband conduit when construction occurs in roadway rights of way.
- Ensure a high level of service to all areas in the region.
- Simplify the process to allow pole attachments.
- Support programs that provide internet access to underserved populations
- Identify and use financing mechanisms to improve broadband access.
- Develop local master plan chapters that describe broadband service and needs.

B. Introduction

1. Project Background

The New Hampshire Broadband Mapping and Planning Program (NHBMPP) is a comprehensive, multi-year initiative that began in 2010 with the goal of understanding where broadband is currently available in New Hampshire, its importance to economic development, how it can be made more widely available in the future, and how to encourage increased levels of broadband access and usage. Funded through the National Telecommunications and Information Administration (NTIA), the NHBMPP is part of a national effort to expand broadband access and adoption.



The NHBMPP is managed by the GRANIT (Geographically Referenced Analysis and Information Transfer) System within the Earth Systems Research Center at the University of New Hampshire (UNH), and is a collaboration of multiple partners. These include: the NH Office of Energy and Planning (OEP), NH Department of Resources and Economic Development (DRED), UNH Cooperative Extension (UNHCE), UNH Information Technology (UNHIT), and the state's nine regional planning commissions (RPCs).

2. Program Components & Objectives

The NHBMPP is comprised of several components, including a broadband availability inventory and mapping effort and a suite of planning and technical assistance initiatives. Following are brief descriptions of these components as well as an overview of the broadband planning initiative.

Mapping

In 2010, UNH GRANIT, the RPCs, and other partners began an inventory and mapping effort aimed at better understanding the current availability of broadband throughout the state through several projects and activities, which include:

- Collecting data semi-annually from the public and commercial entities that provide broadband services in New Hampshire on the location, type and speed of broadband technology available;
- Refining the information collected on broadband availability by initiating a series of verification efforts, including map verification with community collaborators, online speed tests and user surveys, a statewide cell phone reception study, and other related activities;
- Surveying and mapping broadband availability at community anchor institutions (CAIs) such as schools, libraries, hospitals, public safety facilities, and municipal buildings;
- Developing the first public master address file of households located in rural census blocks;
- Collecting and hosting a statewide inventory of cable franchise agreements; and,
- Sharing information and data on broadband availability with the NTIA and the Federal Communications Commission (FCC) on a semi-annual basis for inclusion in the National Broadband Map.

Technical Assistance and Training

UNH Cooperative Extension has taken the lead on developing and administering technical assistance and training opportunities to help businesses, local governments, organizations and individuals better understand the importance of and applications for broadband in today's world. The activities undertaken by UNHCE through the NHBMP include:



- Assessing the broadband training and technical needs of stakeholder groups including educational institutions, small business, municipalities, healthcare providers and organizations to determine topics stakeholders would like to receive training on and applications that would be of use to stakeholders;
- Developing tools and learning modules on topics related to broadband utilization and adoption such as "Leveraging Broadband to Promote Economic Development", "Putting your Business on the Digital Map", and "Three Free Ways to Promote Your City/Town/School via the Web"; and,
- Delivering workshops, training and technical assistance to broadband stakeholder groups to support increased broadband adoption and use.

Capacity Building

A third component of the NHBMP, capacity building, is focused on the development of tools and resources necessary to implement broadband projects within communities and regions across the state. The Director of Broadband Technology, a new staff position at the NH Department of Resources and Economic Development, and project staff from UNHCE and UNH Information Technology are working together to enhance broadband capacity by:

- Encouraging collaboration to establish best practices in policy management, financial resources, and advocacy for business and residential broadband;
- Tracking and reviewing legislation related to broadband and telecommunications;
- Working with the NH Telecommunications Advisory Board, to analyze and assess the state's broadband infrastructure and promote access to affordable and reliable advanced telecommunications services;
- Researching successful community broadband solutions and funding options, including and aggregating them into a toolkit on broadband solutions and funding for NH; and,
- Establishing a Resource Team, who will work with RPCs and broadband stakeholder groups (BSGs) to identify communities prepared to initiate their broadband plans and provide assistance with community broadband decision making.

3. Planning

In 2011, NHBMPP partners engaged in a four-year effort aimed at incorporating the information and momentum gained during the mapping activities to better understand current broadband availability in New Hampshire and plan for increased broadband adoption and utilization through outreach, community engagement, and surveying activities.

As part of an effort to gain a better understanding of broadband at the regional level, each RPC developed a broadband stakeholder group (BSG), comprised of individuals representing a range of sectors, which met quarterly. The BSGs have assisted RPCs in assessing the need for improved broadband capability, availability, and affordability. The BSGs helped the RPCs develop a list of broadband needs and barriers to broadband adoption and utilization. They also assisted with developing goals, objectives, and strategies to overcome barriers in each region.

A major undertaking of the broadband planning component was a sector-based analysis. This activity involved developing and facilitating focus group meetings, structured interviews, and other methods to identify broadband needs and challenges specific to various sectors, including healthcare, education, local government, economic development, and public safety. RPCs conducted focus groups and interviews with representatives from these sectors to better understand the importance of broadband accessibility to each sector.

Additionally, each RPC held public forums throughout the course of the project. These forums were an opportunity to share information regarding ongoing broadband efforts in the region, progress of the NHBMPP, and to receive feedback from community members regarding broadband availability.

Information gathered from the activities described above led to the development of regional broadband plans for each planning commission region in New Hampshire.

Each RPC reviewed and analyzed data collected through the mapping efforts, outreach activities, sector-based analysis, as well as public forums to develop comprehensive documents that highlight the current landscape of broadband availability in the state and identify ways to increase broadband adoption and utilization. The regional broadband plans serve as guidance documents for communities, policy makers, businesses, institutions, and residents to better understand the availability and need for and utility of broadband now and into the future.

4. Understanding Broadband

Broadband Explained

Broadband, also called 'high-speed Internet,' is the umbrella term referring to high-speed Internet access that is always on and is faster than dial-up Internet access. The National Telecommunications and Information Administration (NTIA) defines broadband as "advanced communications systems capable of providing high-speed transmission of services such as data, voice, video, complex graphics, and other data-rich information over the Internet and other networks."¹ As technology capabilities are continually changing, it is important to define what broadband is so that stakeholders can determine where broadband is currently available, and how it can be made more widely available to more people.

Broadband is defined in terms of how fast the user's computer can download and upload information from the Internet. Download is the speed that a computer receives data from the Internet and upload is the speed to send data. The speed at which information can be transmitted depends on bandwidth. Bandwidth is the transmission capacity of an electronic pathway. That capacity can be described in terms of how much data, measured in bits, can be transmitted per second, and is reported in kilobits (Kbps), megabits (Mbps), and gigabits (Gbps). NTIA defines broadband as providing a minimum of 768 Kbps download and 200 Kbps upload. Most broadband technologies have different downloading and uploading speeds, with upload speed typically being more limited. As technology and applications continually change, there are many different types of broadband services as well as resulting speeds and functions while using the Internet.

Although NTIA defines broadband at a 768 Kbps minimum download threshold, download speeds up to 3 Mbps have limited functionality. At up to 3 Mbps Internet users are able to use web-based email, send and receive small to medium-sized documents, and browse the web. However, operating multiple functions may cause potential slowness, making it difficult to conduct necessary business and education operations. Today, in order to use many Internet applications successfully, a minimum download speed of 3 Mbps is required. At 3 Mbps download, users can send and receive photos and word documents through email, conduct multiple

¹ "Broadband: As defined by the NH Broadband Mapping and Planning Program," *New Hampshire Broadband Mapping and Planning Program*, February 15, 2012, <http://iwantbroadbandnh.com/planning-and-assistance>. (accessed July 17, 2013).

functions simultaneously, and access low-quality videoconferencing such as Skype. At 6 Mbps, users can send and receive large documents and files, such as small videos, and can access their company's network while traveling or working from home with a speed of operation that is similar to being in the office. Also, higher quality videoconferencing can be conducted allowing businesses to communicate with clients, partners, and employees. At 10 Mbps telemedicine and telehealth applications are possible and remote education, professional development, and workshops can occur in high definition (HD) quality. At 25+ Mbps real time HD medical imaging and consultation can occur.² As Internet technology and applications continuously emerge and evolve it takes much more than the minimum broadband threshold to operate successful businesses, provide relevant education, and quality medicine.

The New Hampshire Broadband Mapping and Planning Program (NHBMPP) has developed a matrix to assist stakeholders in understanding the many levels of broadband available in the state of New Hampshire today, and the typical functions a user might be able to perform within a range of download and upload speed tiers. Using these tiers, the NHBMPP has established broadband availability categories ("un-served," "underserved," and "served") to describe access to broadband service.

² "Broadband: As defined by the NH Broadband Mapping and Planning Program," *New Hampshire Broadband Mapping and Planning Program*, February 15, 2012, <http://iwantbroadbandnh.com/planning-and-assistance>. (accessed July 17, 2013).



Category	Download Speed	Upload Speed	Typical Functions/Use (functions additive to level above)		
Unserved	< 768 Kbps	< 200 Kbps	<ul style="list-style-type: none"> Email (Client/Server-based; POP) 		
Underserved	768 Kbps to < 6 Mbps	200 Kbps to < 1.5 Mbps	<table border="1"> <tr> <td>Minimum Download Speed: 768 Kbps</td> <td>Minimum Upload Speed: 200 Kbps</td> </tr> </table> <ul style="list-style-type: none"> Web-based email Limited web browsing and shopping Minimal social media use Sending/receiving small documents/files (photos, word processing, invoices) 	Minimum Download Speed: 768 Kbps	Minimum Upload Speed: 200 Kbps
			Minimum Download Speed: 768 Kbps	Minimum Upload Speed: 200 Kbps	
			<table border="1"> <tr> <td>Minimum Download Speed: 1.5 Mbps</td> <td>Minimum Upload Speed: 768 Kbps</td> </tr> </table> <ul style="list-style-type: none"> Web browsing and shopping Medium social media use Sending/receiving medium-sized documents/files (photos, word processing) Limited streaming content; buffering a concern Standard Definition (SD) content VPN access possible, but speed of operation not critical to job function Internet integrated in daily life, and “always” connected VoIP (Voice over IP, i.e. telephone over the Internet) 	Minimum Download Speed: 1.5 Mbps	Minimum Upload Speed: 768 Kbps
			Minimum Download Speed: 1.5 Mbps	Minimum Upload Speed: 768 Kbps	
<table border="1"> <tr> <td>Minimum Download Speed: 3 Mbps</td> <td>Minimum Upload Speed: 768 Kbps</td> </tr> </table> <ul style="list-style-type: none"> Medium to high social media use Sending/receiving medium to large-sized documents or files Streaming SD content; downloading High Definition (HD) content (movies, video) VPN access needed, speed of operation important but not critical to job function Low quality, small window frame videoconferencing (Skype) Cloud-based computing and data storage 	Minimum Download Speed: 3 Mbps	Minimum Upload Speed: 768 Kbps			
Minimum Download Speed: 3 Mbps	Minimum Upload Speed: 768 Kbps				
Served	6 Mbps to 25+ Mbps	1.5 Mbps to 6+ Mbps	<table border="1"> <tr> <td>Minimum Download Speed: 6 Mbps</td> <td>Minimum Upload Speed: 1.5 Mbps</td> </tr> </table> <ul style="list-style-type: none"> Heavy social media use Sending/receiving large documents or files (photos, word processing, small videos) Streaming HD content (movies, video); buffering not a concern VPN access needed, speed of operation critical to job junction Higher quality, codec-based videoconferencing Multi-player online gaming 	Minimum Download Speed: 6 Mbps	Minimum Upload Speed: 1.5 Mbps
			Minimum Download Speed: 6 Mbps	Minimum Upload Speed: 1.5 Mbps	
			<table border="1"> <tr> <td>Minimum Download Speed: 10 Mbps</td> <td>Minimum Upload Speed: 3 Mbps</td> </tr> </table> <ul style="list-style-type: none"> Sending/receiving large files and small to medium-sized databases HD quality, codec-based, large frame videoconferencing; multiple sites/users Remote synchronous education, professional development, workshops, etc., facilitated simultaneously at multiple classrooms and/or other locations Telehealth/telemedicine applications possible 	Minimum Download Speed: 10 Mbps	Minimum Upload Speed: 3 Mbps
			Minimum Download Speed: 10 Mbps	Minimum Upload Speed: 3 Mbps	
<table border="1"> <tr> <td>Minimum Download Speed: 25+ Mbps</td> <td>Minimum Upload Speed: 6+ Mbps</td> </tr> </table> <ul style="list-style-type: none"> Sending/receiving medium to large-sized databases HD quality, codec-based, large frame videoconferencing connecting multiple sites High speed end to end network and business to business applications Telemetry-based applications Real-time HD medical imaging and consultation (remote dermatology, etc.) “Internet 2” connectivity and applications 	Minimum Download Speed: 25+ Mbps	Minimum Upload Speed: 6+ Mbps			
Minimum Download Speed: 25+ Mbps	Minimum Upload Speed: 6+ Mbps				

Source: New Hampshire Broadband Mapping and Planning Program
<http://www.iwantbroadbandnh.org>

How It Works

Broadband can be thought of as consisting of three hierarchical components, or layers, much like the nation's highway system of interstate roads, state roads and local roads.

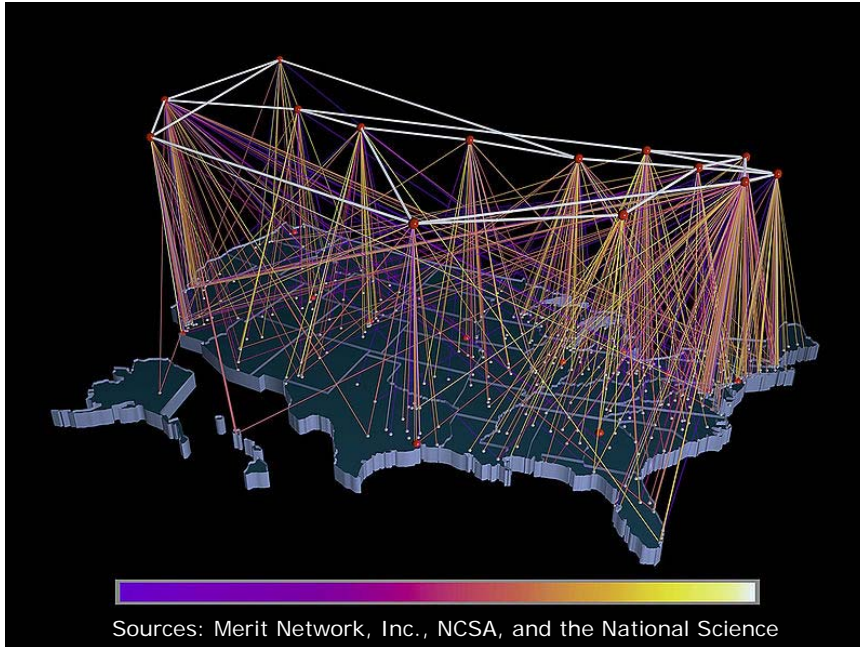

Sources: Merit Network, Inc., NCSA, and the National Science

At the highest level is the Internet "backbone" which is hosted by large commercial, government, academic, and other high-capacity network centers. The "middle mile" refers to the segment linking a network operator's core network to the local network plant. In order to transport the Internet to homes and businesses, known as the "last mile," it can be most cost-effective to increase the reach of

the "middle mile" through community anchor institutions. Community anchor institutions are typically municipal libraries and Town offices, hospitals and schools, emergency services and public safety operations, and large businesses that have the means and capacity to access broadband-based services. The majority of home and small business users rely on the last mile hosts, Internet service providers (ISPs), to obtain broadband services.³

³ State of New Hampshire, Department of Resources and Economic Development and The Telecommunications Advisory Board, State of New Hampshire Broadband Action Plan: Appendix A, 2008, <http://www.nheconomy.com/uploads/Broadband-Action-Plan-Appendices.pdf>. (accessed July 17, 2013).

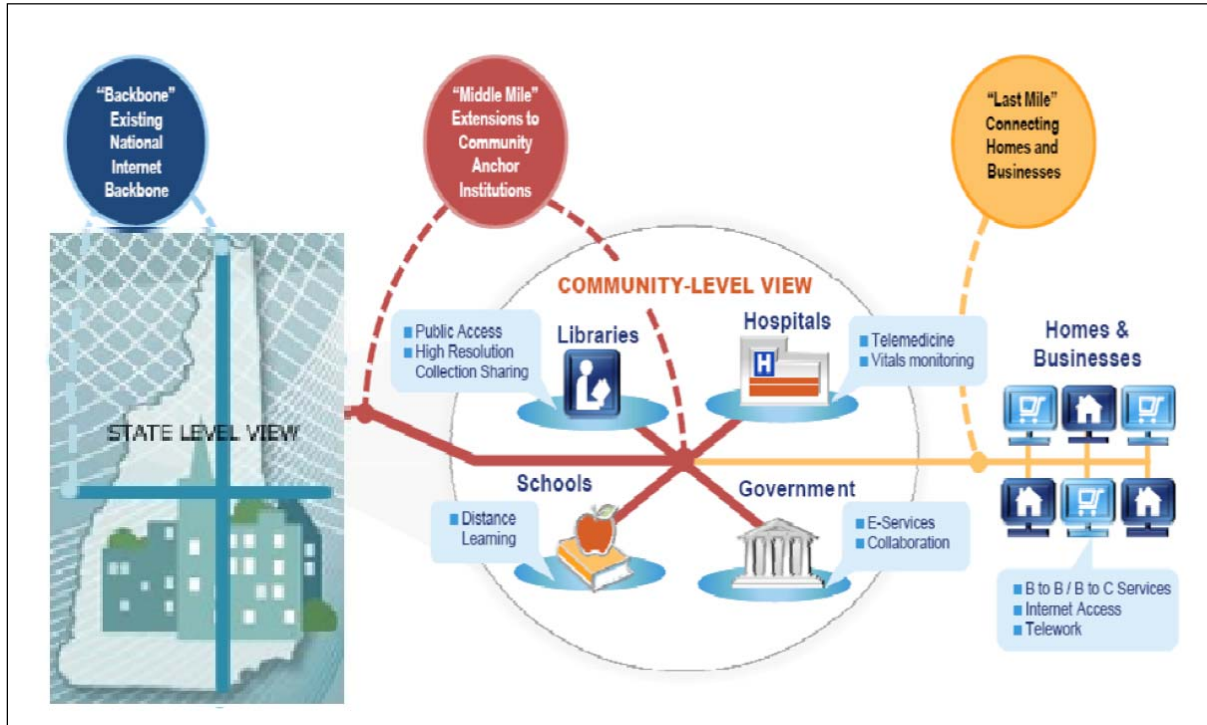

Source:

<http://www.whitehouse.gov/sites/default/files/20091217-recovery-act-investments-broadband.pdf>

There are many different broadband delivery technologies. These technologies can be separated into two major categories of wired and wireless broadband. Wired technologies include Digital Subscriber Lines (DSL), Cable Modem, Fiber Optics, Leased Lines (T1), Broadband over Powerline (BPL). Wireless technologies include mobile wireless (3G, 4G, LTE, WiMax), Wi-Fi, satellite, and Wireless Internet Service Providers (WISP).⁴ Wired broadband technologies bring a wire connection to the home or business. Often, a Wi-Fi router is used by the subscriber to share the Internet connection wirelessly among different devices within the home, such as a laptop computer or tablet.

- Digital Subscriber Lines (DSL) is the existing landline-wired technology commonly used by residential and small businesses. DSL uses copper phone lines to deliver direct, one-on-one connections to the Internet, allowing users to not have to share bandwidth with neighbors. Users must be located within 18,000 feet (3.4 miles) of a phone company’s central office, which means service is often unavailable in rural areas.⁵ The most common DSL connections are asymmetric, with networks offering more bandwidth and faster speeds for download compared to upload, since residential users

⁴ “Wireless Internet 101,” *Institute for Local Self-Reliance*, <http://www.ilsr.org/content-types/fact-sheets-resource-archive/?contenttype=fact-sheets-resource-archive&initiative=broadband>. (accessed June 2013).

⁵ Shuffstall, Bill, Monica Babine, and Andy Lewis, “Connecting Communities,” *The National e-Commerce Extension Initiative*, <http://www.connectingcommunities.info/>. (accessed July 2013).

predominately are downloading more information from the Internet than uploading. Symmetric types of DSL provide equal bandwidth for upload and download, which is sometimes marketed as “Business DSL” as companies often have greater needs for uploading, or transmitting data. The dominant provider using DSL in the RPC region is Fairpoint. There are two known local providers of DSL in the region, Fairpoint (Regionwide) and Granit State Communications.

- Cable Modem based Internet service uses the cable television network to deliver broadband. This type of service is typically faster than a common, asymmetric DSL connection. Cable networks are a shared connection, so speeds can slow during peak usage times due to congestion when people in the same neighborhood are online. The primary provider of cable modem based service within the region is Comcast.

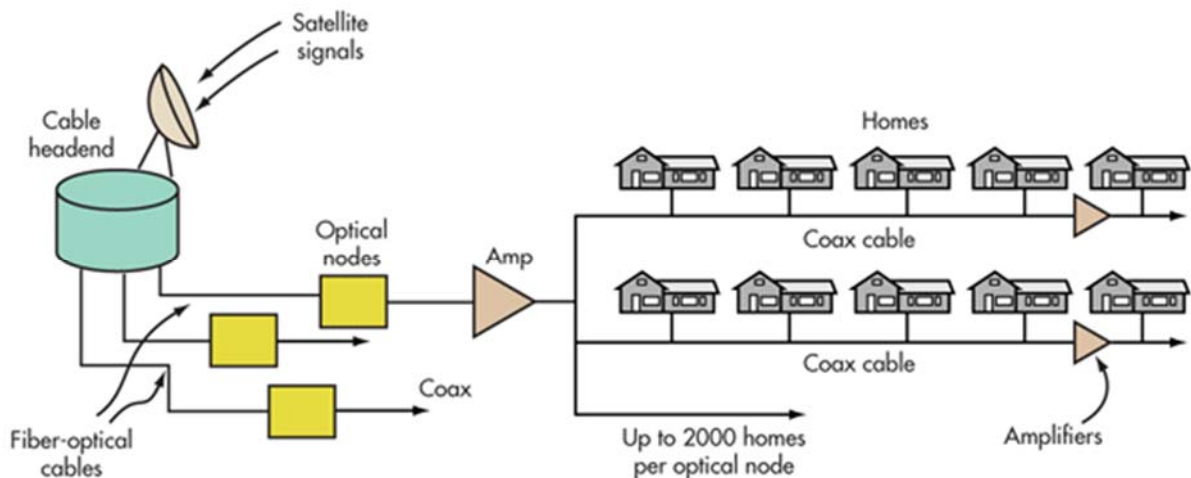

Source: L. Frenzel – Electronic Design

- Fiber optic systems use lasers across very thin strands of glass creating reliable, resilient technology that has an extremely high capacity for speeds and data transmission. There is a high cost associated with laying out the fiber network but once in place the system can be easily upgraded and maintained, with lower operating costs than DSL, cable, or wireless networks.⁶ Building out the fiber network is currently the most effective means to provide the highest capacity broadband Internet. The dominant fiber optic based provider in the RPC region is Fairpoint.

- Cellular broadband is available through many technologies, including mobile wireless (3G, 4G, and LTE). Unlike wired technologies, which bring wires directly to a location, wireless technologies use radio frequencies through transmitters and receivers to deliver broadband. Wireless broadband can be categorized as wireless networks or satellite. Cell phones,



M.O. Stevens, Wikimedia Commons

⁶ “Broadband 101,” Institute for Self-Reliance, <http://www.ilsr.org/content-types/fact-sheets-resource-archive/?contenttype=fact-sheets-resource-archive&initiative=broadband>. (accessed on July 17, 2013).

and other mobile devices, use mobile wireless licensed technologies such as 3G, 4G, LTE, WiMax, and other networks. Cellular broadband is available in most areas of the RPC region from multiple carriers, including Verizon Wireless, AT&T, Sprint and T-Mobile.

- Wireless Internet Service Providers (WISP) are designed to cover large areas using point-to-multipoint networks to broadcast wireless data up to 20 miles. A signal is broadcast from a base station and is received by a fixed wireless antenna mounted on a customer's premises. A combination of a Wi-Fi Hotspot and a WISP can enable a Neighborhood Internet Service Provider (NISP) or a Wi-Fi Hotzone. A Wi-Fi Hotzone can cover an area such as a neighborhood, shopping mall, or campground.⁷ WISP networks can provide "last mile" solutions and broadband availability to rural areas where it is often cost-prohibitive to build wired networks. The RPC is unaware of WISP providers in the region.
- Satellite Internet users send and receive information via small dishes installed on the premises to a satellite in space which retransmits the signal to a network operation center that is connected to the Internet. Satellite-based Internet connection can be interrupted by objects and weather, and broadband upload speeds are typically slower than wired or other wireless networks.⁸ While wireless broadband can offer mobility and access for rural locations, wireless connections are unlikely to overtake the wired network which is likely to maintain higher speeds and lower costs, especially when compared to a ubiquitous fiber network. Wireless and wired broadband networks can be thought to complement each other to create available broadband Internet connections.
- Wi-Fi or 'hotspots' are designed to broadcast the Internet for several hundred feet. They are used by public and private networks, including businesses for their employees or retailers for their customers, who connect to the Internet using built-in Wi-Fi cards in their mobile devices (e.g. laptops, tablets, or cell phones, etc.). While this is not a primary means for distribution of Internet service in most cases, it is a type of networking that could be expanded in some cases by Internet service providers.

Why Broadband Is Important

Today, Broadband is today what electricity was to New Hampshire in the 1930's - a necessity. As a predominantly rural state with limited resources, the availability of high-speed internet is one of the most significant factors that will impact the ability

⁷ Shuffstall, Bill, Monica Babine, and Andy Lewis, "Connecting Communities," *The National e-Commerce Extension Initiative*, <http://www.connectingcommunities.info/>. (accessed July 2013).

⁸ Shuffstall, Bill, Monica Babine, and Andy Lewis, "Connecting Communities," *The National e-Commerce Extension Initiative*, <http://www.connectingcommunities.info/>. (accessed July 2013).

of communities to achieve economic growth and maintain quality of life. In a relatively short period of time, fast and reliable broadband has become essential for economic and community development and is critical infrastructure for public safety, education, health care, business and government operations.⁹

Communities today face many challenges: a competitive global marketplace; an aging population; the need for a better-educated and better-prepared workforce; and, access to health care. These issues are magnified in rural areas by far distances between households and services, scarce resources and changing demographics. The financial resources traditionally available to overcome these challenges are often unavailable to rural communities and regions. New solutions are required. Broadband can help community leaders find innovative solutions to these challenges.

There is no doubt we live in an information society, and broadband enable all types of information to be within a few keystrokes away. Whether this is training for a new skill, a new language, or completing an online course - broadband facilitates the access of information in many different forms.¹⁰ The receipt and delivery of information over the Internet at high speeds is seen as an essential tool for accomplishing tasks that contribute positively to economic activity and social welfare.

In 2010, it was estimated that there were almost 200 million Americans with access to broadband at home, up from 8 million in 2000.¹¹ A November 2013 report from the University of New Hampshire's Broadband Center of Excellence, entitled "Broadband 2020: Achieving Ubiquity" states that an estimated 96% of residents in the United States had access to broadband networks that provide downstream data rates of 6 megabits per second

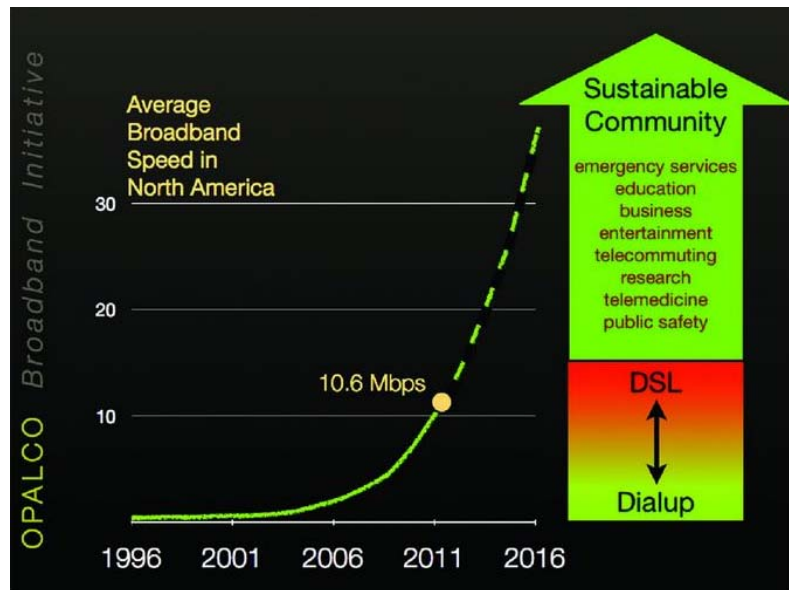

Source: <http://www.opalco.com/broadband/do-we-really-need-faster-internet-service-2013-05-01/>

⁹ "Building Community Capacity through Broadband (BCCB) Initiative," *University of Wisconsin Extension*, November 2010, http://www.uwex.edu/broadband/documents/BCCBUWEXFAQ_rev_11_18_10withmap.pdf. (accessed June 2013).

¹⁰ David Salway, "Why is Increasing Broadband Adoption so Important to Society?," *About.com Guide*, <http://broadband.about.com/od/barrierstoadooption/a/Why-Is-Increasing-Broadband-Adoption-So-Important-To-Society.htm>. (accessed July 2013).

¹¹ Federal Communications Commission, *Connecting America: The National Broadband Plan*, 2010, http://www.broadband.gov/plan/11-education/#_edn16. (accessed July 17, 2013).

or faster in 2012. While this is an impressive increase, there are still many Americans with insufficient access to broadband services. In New Hampshire, access varies from good coverage and availability in denser areas of the state to areas of un-served and under-served communities in the northern, western and eastern parts of the state. This variability can lead to disparities in economic opportunity, education, community vitality, public health and safety, and quality of life.

Broadband Importance by Sector

Education

Broadband is an important tool to enhance access to and improve the quality of education at all levels in New Hampshire and beyond. Broadband-enabled teaching and learning has the potential to extend learning beyond the limits of the classroom, provide more customized learning opportunities, and increase the efficiency of school systems.¹² The availability of a wide range of internet based resources such as distance learning programs, online learning modules, and digital textbooks allows students to engage in multimedia lessons, take virtual trips, and communicate with classrooms in other parts of the world. These tools offer educators a platform to share curricula and provide adult learners easy access to professional development or educational opportunities online.

However, as teaching and broadband technology become increasingly intertwined, students lacking access to adequate broadband both in school and at home will be unable to keep up with educational trends and potentially, be less prepared than their peers in more 'connected' areas. The State Educational Technology Directors Association recommends that K-12 schools have access to broadband speeds of 100 megabits per second for every 1,000 students and staff by the year 2014 and 1 gigabyte per second by 2017.¹³ Although most schools provide some level of internet access, too often the speeds of these connections fall short of what is considered appropriate or necessary.¹⁴ This need for improved broadband connections in schools will only increase over time; especially, as educators transition to web-based content and resources and more states require online assessments and testing.

Health

With increasing and changing health needs, ranging from rising health care costs, to managing chronic illnesses, to meeting the needs of an aging population, and a

¹² Federal Communications Commission, *Connecting America: The National Broadband Plan*, 2010, http://www.broadband.gov/plan/11-education/#_edn16. (accessed July 17, 2013); United National Educational, Scientific, and Cultural Organization, Technology, *Broadband and Education: Advancing the education for all agenda*, Jan. 2013, <http://unesdoc.unesco.org/images/0021/002196/219687e.pdf>. (accessed July 17, 2013).

¹³ C. Fox, J. Walters, G. Fletcher and D. Levin, "The Broadband Imperative: Recommendations to Address K-12 Education Infrastructure Needs," *State Education Directors Technology Association*, 2012, <http://www.setda.org/web/guest/broadbandimperative>. (accessed July 17, 2013).

¹⁴ C. Fox, J. Walters, G. Fletcher and D. Levin, "The Broadband Imperative: Recommendations to Address K-12 Education Infrastructure Needs," *State Education Directors Technology Association*, 2012, <http://www.setda.org/web/guest/broadbandimperative>. (accessed July 17, 2013).

shortage of specialists in rural locations, broadband Internet plays an important role in how these issues are addressed.

Telehealth, the broader term incorporating telemedicine, is the transfer of electronic medical data (images, sounds, live video and patient records) from one location to another. It includes the use of electronic information and telecommunications technologies to support long distance clinical care, patient and professional health related education, public health, and health administration.¹⁵ New Hampshire, with rural geography, scarcity of local specialty medical services, and high percentage of elderly residents, can benefit from telehealth systems.¹⁶ Broadband Internet is necessary to continue supporting current and emerging telehealth applications for patients, providers, hospitals, and health care businesses.

Electronic medical records systems enable providers to collaborate in patient care by accessing treatment information from different locations. Patients can have better access to their medical records and information in an effort to better engage patients and families in managing their health. Video conferences allow physicians to have video consultation and monitor treatment of patients remotely. It also increases the reach of specialized physicians and research.¹⁷ Broadband Internet connection plays an essential role in the ability to incorporate the latest health technologies that benefit patients, health providers, and health industry businesses.

Community Support / Government

From providing a displaced community member with food and shelter to organizing community initiatives, local governments and community support organizations in New Hampshire deliver a wide variety of valuable services to their constituents. Demands for services are constantly increasing, yet organizational budgets rarely follow that same trend. Broadband connectivity provides the capacity to more efficiently and cost-effectively deliver services while opening up possibilities for new services and facilitating more robust public participation.

Equal in value to the administrative efficiencies associated with broadband technology, are the accessibility opportunities broadband creates. Online meetings, surveys, blogs and other modules offer new ways for a larger percentage of the population to watch and participate in community decision-making processes.

¹⁵Louis Kazal Jr. and Anne Conner, "Planning and Implementing a Statewide Telehealth Program in New Hampshire", 2005, <http://www.endowmentforhealth.org/uploads/documents/resource-center/Planning%20and%20Implementing%20a%20Statewide%20Telehealth%20Program%20in%20NH.pdf>

¹⁶ Louis Kazal Jr. and Anne Conner, "Planning and Implementing a Statewide Telehealth Program in New Hampshire", 2005, <http://www.endowmentforhealth.org/uploads/documents/resource-center/Planning%20and%20Implementing%20a%20Statewide%20Telehealth%20Program%20in%20NH.pdf>

¹⁷ Federal Communications Commission, *Connecting America: The National Broadband Plan*, 2010, http://www.broadband.gov/plan/11-education/#_edn16. (accessed July 17, 2013).

Similarly, technologies utilized by community support organizations now enable them to administer one-on-one services without travelling.

While new applications allowing for improved public sector interaction and transparency will continually surface, their reliance on perpetually maintained broadband infrastructure will remain a constant.

Public Safety

New Hampshire is a predominantly rural state, where firefighters, law enforcement and emergency medical personnel cover wide geographic areas. These public safety officials are often required to quickly make potentially life-saving decisions in the field, despite the challenges of rugged terrain and natural and man-made disasters. Public safety personnel need the ability to quickly communicate with each other, access online resources (via a PC or mobile device), connect to networks, and quickly transfer important video and data files during emergencies

Economic Development/Business

The total economic impact of broadband in New Hampshire was estimated at \$634 million in 2010 and in 2011, 11,000 net new jobs were created as a result of expanded broadband.¹⁸ Broadband and economic development are connected in that, as we progress into the future, both are needed for each to be successful.

Jobs depending on broadband and information and communications technology will grow by 25% between 2008 and 2018 or at a rate of 2.5% faster than the average for other occupations and industries.¹⁹ To say that broadband technology has not changed the way we do business is to deny the tremendous impact that computers have had on our lives worldwide. In 2011, 73% of New Hampshire households and businesses had access to broadband and, nationally in 2012, 66% of adults have broadband at home, which is up from 3% in 2000.²⁰ Investment in broadband is showing benefits for small businesses and local economies, as well. A Connect Iowa study of the state's small businesses found that Iowa small businesses generate \$1.9 billion in online sales and that small businesses with a broadband connection have revenues that are \$200,000 higher annually than those which do not.²¹

Broadband and broadband-dependent applications allow small businesses to increase efficiency, improve market access, reduce costs and increase the speed of both transactions and interactions. By using Web-based technology tools, 68% of

¹⁸ R. Crandall and H. Singer. "The Economic Impact of Broadband Investment." *National Cable and Telecommunications Association*, 2010.

¹⁹ Federal Communications Commission, *Connecting America: The National Broadband Plan*, 2010, http://www.broadband.gov/plan/11-education/#_edn16. (accessed July 17, 2013).

²⁰ The Pew Internet and American Life Project, Sept. 2012, available at <http://www.pewinternet.org/>.

²¹ Anna Read and Damon Poter, "Building High-Speed Communities," *APA Planning Magazine*, March 2013.

businesses surveyed boosted the speed of their access to knowledge, 54% saw reduced communications costs and 52% saw increased marketing effectiveness.²² The use of broadband by small businesses has proven to be an efficient and cost effective tool. Business statistics have shown that small businesses have consistently been the backbone for job and wealth creation in the US economy. The use of broadband has truly served to enrich that position into the 21st century.

C. Vision, Goals, and Objectives for Broadband in the Region

In today's interconnected, global economy, broadband is considered a critical infrastructure for both businesses and citizens. To enable municipalities, businesses, and residents to benefit from the economic, educational, and recreational opportunities provided by broadband access, the Rockingham Planning Commission (RPC) envisions a region in which broadband is seen as critical infrastructure and maintaining and enhancing the capacity and adoption of broadband ensures the region thrives, adapts and captures these opportunities.

The challenge of ensuring that the State of New Hampshire's citizens and organizations have adequate levels of broadband to compete in the 21st century economy will require leaders of state and local governments and the private sector to continue to work together to evaluate best practices, encourage of public-private partnerships where necessary, and understand both the supply (deployment challenges) and demand (usage of broadband to spur further deployment) dynamics in the State and the RPC region. Unlike traditional infrastructure, such as roads, bridges, and transmission lines, which are part of the built environment, broadband is largely invisible to users, making its relevance easier to overlook.

A 2007 report from the Brookings Institute found that for every 1 percentage point increase in broadband penetration in a state, employment is projected to increase by 0.2 – 0.3% per year. And for every dollar invested in broadband the economy benefits nearly three dollars. Broadband is a tool to improve productivity, quality of life, and share information. It is also a commodity, and based on research from the Pew Research Center's Internet and American Life Project, broadband is a hot commodity, reaching a 50% adoption rate faster than other technologies, including the personal computer, color television, and cell phones.

In the RPC region, most sectors of the economy perceive broadband service to be adequate. However, lack of competition is seen as preventing consumer choice and creating high costs for service. Lack of information on the location and type of broadband service available is an obstacle to planning for service improvements.

²² Federal Communications Commission, *Connecting America: The National Broadband Plan*, 2010, http://www.broadband.gov/plan/11-education/#_edn16. (accessed July 17, 2013).

Many communities in the RPC region are actively engaged in local economic development and leadership and coordination on assessing and delivering adequate broadband is needed to support these local initiatives. As the region's economy continues to shift from traditional manufacturing to a more diversified industrial and commercial base, broadband must be seen by decision makers in the public and private sector as critical infrastructure, much in the way that highways and energy are viewed as critical infrastructure.

Economic development leaders and municipal officials in the region view broadband as an essential service that is needed to:

- Create and retain high-skill and higher-wage jobs
- Increase business profitability
- Provide access to educational opportunities
- Improve the efficiency of municipal services
- Enable faster emergency response
- Improve access to health care

According to Laurel Bistany, Executive Director of the Regional Economic Development Center of Southern New Hampshire, Broadband access is essential to future economic development in the region. Bistany states, "Broadband is rapidly becoming the new infrastructure issue in southeast New Hampshire. Businesses increasingly inquire about, and demand, fast, reliable service. Availability is critical to attracting and retaining businesses in the region and without a concrete plan for increasing bandwidth and service we will not be as competitive as some of our neighbors."

E. Existing Conditions

1. Regional Overview

Geography and Physical Landscape

The RPC region encompasses twenty six towns in southeastern New Hampshire, totaling 230,778 acres or 360.6 square miles. The region enjoys the benefits provided by a multi-state regional economy created by the State of Maine to the north and the Commonwealth of Massachusetts to the south. Geologically, the RPC region lies within the Southern part of the New England and Eastern New York Uplands. Elevations range from sea level along the Atlantic Ocean to about 1,350 feet above sea level, including lands from the coastline of New Hampshire and extending inland to the Merrimack River Valley. The region also includes the Great Bay estuary, a tidal bay that encompasses five major river systems. The estuary offers a variety of diverse habitats ranging from tidal mudflats to upland forests.

Land use in the region is characterized by a mix of rural, suburban and small urban centers.

Population Characteristics

The RPC region encompasses twenty six towns in Rockingham County. According to the 2010 US Census, municipal populations in the region ranged from 753 residents in the Town of Newington to 21,233 in the City of Portsmouth. Several coastal towns in the region experience wide ranges in population during the summer months, such as the Town of Hampton with a permanent population in 2010 of 14,976 and an estimated population of 150,000 during peak summer time events. The total population in the region in 2010 according to the US Census was 178,383.

The nine regional planning commissions in New Hampshire, working on behalf of the NH Office of Energy and Planning, contracted with RLS Demographics, Inc. to produce the first post-2010 US Census set of data population projections for the state. The data shows that the population growth rates for Rockingham County, as well as all of New Hampshire, are projected to decline over the next twenty year period

Population Growth History
RPC Region, Rockingham County, NH and State of NH

	1990	2000	2010	2020	2030	Avg. Annual Growth 1990-2010	Avg. Annual Growth 2010-2030
RPC Region	152,071	168,288	178,383	184,645	191,985	1.01%	0.58%
Rockingham County	235,845	277,359	295,223	306,867	319,065	1.63%	0.63%
New Hampshire	1,109,252	1,235,786	1,316,470	1,359,836	1,412,041	1.08%	0.63%

Sources: US Census Bureau and RLS Demographics, Inc.

Socioeconomic Conditions

Housing supply and prices, employment, income, and education are all factors influencing economic development in the RPC region. US Census data shows the annual growth rate of housing units in the RPC region between 2000 and 2010 was 1%, reflecting the slowing of population growth in the region and State.

Much of the RPC region lies within the Boston metropolitan area and is strongly influenced by the metropolitan area with respect to housing, employment, and overall economic activity. According to the US Bureau of Labor Statistics, in 2012, the unemployment rate in the region averaged 5.8%. While this unemployment rate remains well below the nation’s average annual employment rate in 2012 of

8.1%, it is significantly higher than the region experienced in the five years preceding the recession when it commonly averaged below 3%.

Household income in the RPC region in 2011 was reported by the American Community Survey (ACS), US Census Bureau to be \$73,949. For the same period the household income for New Hampshire was \$64,664 and the US average household income was \$52,762. Data on educational attainment in the region is also collected by the ACS and 42% percent of the population in the RPC region earned a Bachelor's or Graduate/Professional degree. The ACS estimates the top three employment sectors in the region were educational services, and health care and social assistance (21.4%); retail trade (13.2%); and, manufacturing (12.4%).

The US Census Bureau estimates that 9.4% of workers worked from home at least one day per week in 2010. It is anticipated that this sector of the workforce will continue to grow and require home access to broadband.

Anticipated or Significant Demographic/Economic Trends

The Regional Economic Development Center of Southern New Hampshire (REDC) worked with noted demographer Peter Francese to analyze the data produced by RLS Demographics, Inc. and identify potential economic impacts to the region. Francese concluded that population growth in the region has been slowing since 2000 and is attributed to a lack of job growth resulting from the Great Recession and from tighter land use restrictions by towns which have discouraged housing development.

The RPC region is within one of the nation's slowest growth areas. Between the 2010 US Census and mid-2012, New England's population increased just 0.82% compared to the national growth rate of 1.67%. Such a slow growth rate means the average age of residents in the region will continue to rise. In addition, many communities in the region had an out-migration of young adults over the past decade. Francese concludes that this unbalanced age distribution has short and long-term implications for the region. There may be positive economic benefits in the short-term because household income and spending on household goods and services is highest in the 45-64 age group. In the long-term, the aging population could result in very low workforce growth in future years, as well as a high demand for healthcare and other services related to an aging population.

2. Regional Broadband Availability

Broadband planning is an essential component of maintaining the RPC region's competitiveness as a place to work, live and play. It is an important part of community and regional strategies designed to attract new industry, business and a competitive workforce. Historically, commercial and industrial land use in the region first clustered near access to ocean and river ports and then to railroads and

highways. In the rapidly growing digital economy, access to technological infrastructure such as broadband becomes as important for economic growth as the physical location of a business or industry.

History of Broadband Planning in the RPC Region

In today's world, business growth is increasingly built on the fusion of the physical and the digital. Broadband has become an essential component to economic development, as well as to telemedicine, education, and all forms of communication from email to teleconferencing and social media. The development of a national broadband access system has been compared to the creation of the interstate highway system in the mid-twentieth century and to the establishment of a reliable, standardized electrical distribution system in the early 20th century.

The RPC region has benefited from several State-led broadband planning initiatives. Since 2000, with the Department of Resources and Economic Development and the Division of Economic Development providing leadership and shaping policy for in-state telecommunications and broadband, the State of New Hampshire has worked aggressively through its [Telecommunications Advisory Board](#) and key partners to increase deployment of broadband services throughout the state. The resulting State of NH Broadband Action Plan was published on June 30, 2008 by Berry, Dunn, McNeil, and Parker.

The position of Director of Broadband Technology was created by SB159 and signed into law by Governor John Lynch on July 14, 2009. In late 2009, a director was hired and charged with coordinating the planning and development of a comprehensive broadband plan for the state.

The State's broadband mission is to

- expand the availability of affordable broadband Internet access for all people, businesses and community organizations.
- promote the use of broadband to improve the quality and availability of health care, education and government services.
- work collaboratively with partners to develop an ongoing census of the broadband network infrastructure and related services to unserved and underserved areas of our state.
- foster statewide collaborative efforts in which ideas, experiences and resources can be shared in order to develop new ways of harnessing the Internet for the public good.

According to the NH Division of Economic Development and the National Telecommunications Information Administration (NTIA) national assessment, adoption of broadband has increased significantly in the past two years. In 2010, NH had a 73% broadband penetration rate (2nd in the Nation). In March 2013, NH increased broadband penetration rate to 88%. In September 2013, NH increased broadband penetration rate to 96%. Estimates on investments in

infrastructure since 2008 equal \$562 million, with 11,000 net new jobs created as a result of expanded broadband since 2010.

In addition, the RPC has been working closely with UNH, NH Office of Energy and Planning, and all the other regional planning agencies in the state to complete the NH Broadband Mapping and Planning Program (NHBMP, described at the beginning of this report), and to assess the needs and deficiencies of broadband in the region.

Results of Broadband Mapping

UNH along with its partners on the NH Broadband Mapping Program began mapping Community Anchor Institutions (CAIs) in 2010. This initiative is part of a national effort, led by the National Telecommunications Information Administration (NTIA), to create and maintain a searchable, public database of information on broadband availability in the United States. It is also the first comprehensive effort to understand where broadband is currently available in New Hampshire. Broadband is defined in terms of how fast data can be downloaded and uploaded from the Internet. That capacity can be described in terms of how much data, measured in bits (8 bits to 1 Byte), can be transmitted per second, and is reported in kilobits (Kbps), megabits (Mbps), and gigabits (Gbps). NTIA defines broadband as providing a minimum speed of 768 Kbps download and 200 Kbps upload. The NHBMP has chosen to consider areas with available broadband download speeds less than 768 Kbps as 'un-served' and areas with download speeds of less than 6 Mbps as 'underserved.'

The maps and information included in this section represent data received on broadband availability through UNH's direct work with over 40 of the state's 63 identified broadband service providers and through an inventory 4,062 community anchor institutions (CAIs) across the state. This data has been updated every six months since 2010 to ensure the information remains accurate and current. The RPC region has broadband providers and 493 (12%) of CAIs in the state. The information presented in the maps included in this section of the report is based on data collected as of March 2014.

Information on the maps included in this section is displayed according to NTIA guidelines. Speeds shown are the maximum advertised speeds for the geographic features depicted, and must exceed the NTIA minimum definition for broadband speed (currently 768 kbps download and 200 Kbps upload) to be included. Actual speeds may vary due to the granularity and currency of the data, technological limitations, limitations and latency between the survey respondent and the speed test server

Map 1 - Broadband Availability at Community Anchor Institutions

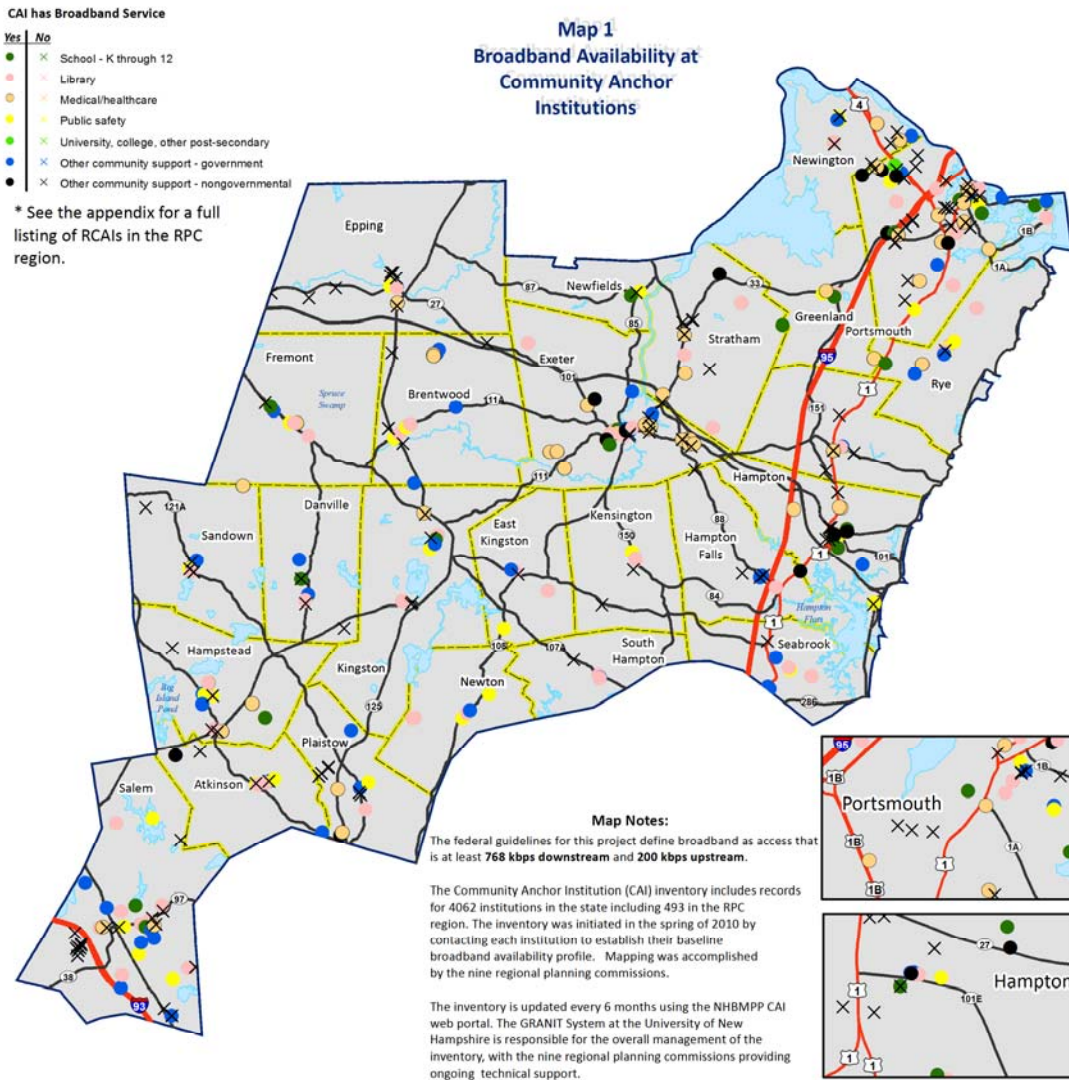

Map 1 – Broadband Availability at Community Anchor Institutions- illustrates the location and broadband access status of 493 CAIs in the Rockingham Planning Commission Region. Information regarding the internet speeds, cost of service, types of technology, service provider, and level of satisfaction with current service was collected from each of these CAIs through a comprehensive survey completed by RPCs in 2010. Since that time, this information has been verified and updated semiannually by UNH and RPC staff. On this map the CAIs are grouped into the following categories and represented by different colors (dark green = K-12 schools; pink = libraries; light green = colleges and universities; yellow = public safety; brown=health/medical facilities; blue = governmental organizations; black = other non-governmental organizations). Circles represent CAIs that identified having access to broadband and/or a minimum of 768Kbps downstream and 200 Kbps upstream. Xs represent those CAIs that did not report have access to broadband. The report Appendix includes a full

listing of the CAIs grouped by community, including broadband access status as they have reported it.

Map 2 - Maximum Advertised Download Speed

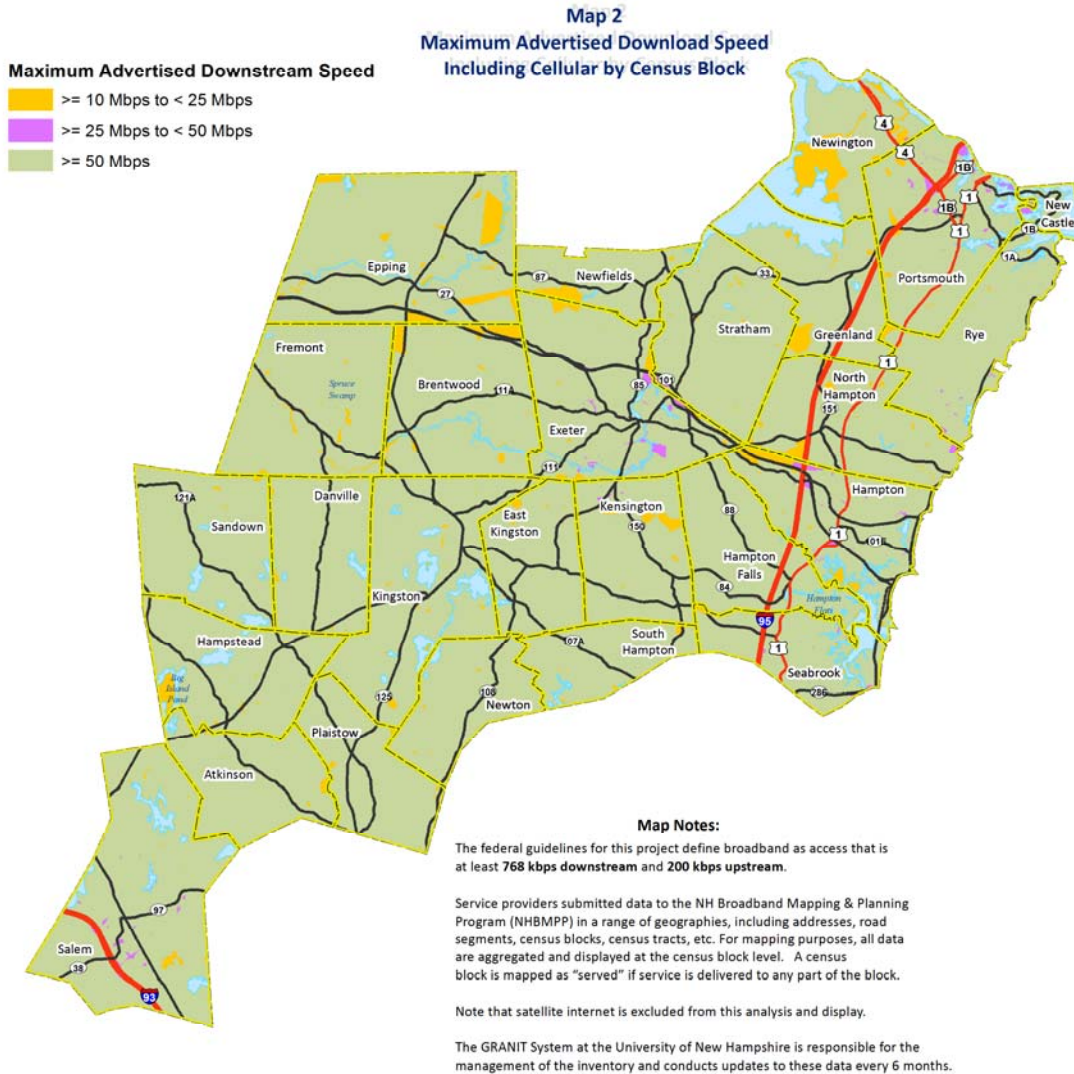

Map 2 – Maximum Advertised Download Speed - displays the maximum download speeds available to customers as advertised by service providers in the Rockingham Planning Region. It is important to note that information on broadband availability presented in Map 2 and subsequent maps in this section is mapped at the U.S. Census block level. This level of generalization creates a significant limitation in the site or address level accuracy. The Census block is the smallest geography measured by the U.S. Census Bureau. These blocks are determined by population and can be greater than 2 square miles in size, especially in less densely populated areas. If a broadband provider offers service to any location within a census block, the entire block is depicted as having access to this level of service. In addition, the information made available to the NHBMPP does not differentiate between speeds provided for business/commercial service and residential broadband service. Because of these

limitations, Map 2 and Map 3 also depict overstated levels of broadband service that may not reflect of the types of service available to a specific site or neighborhood in the region. The different colors presented on Map 2 represent broadband speed tiers.

Map 3 - Degree of Competition for Broadband Availability

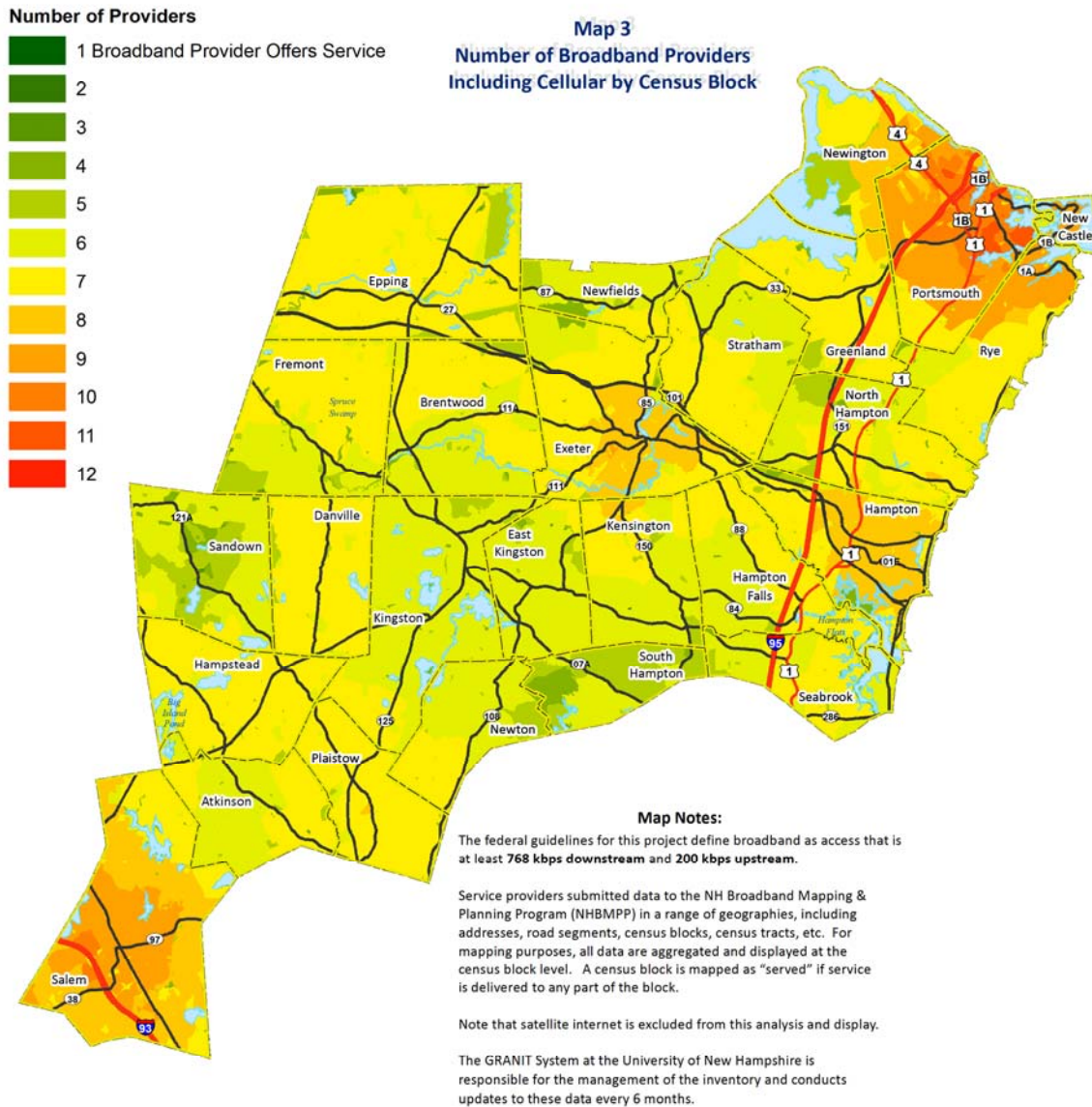

Map 3 – Degree of Competition for Broadband Availability - shows the number of broadband providers actively offering service within the Rockingham Planning Region. Providers represented on this map include fixed wireline, wireless, and mobile internet service providers. Similar to Map 2, the information is displayed at the census block level. Areas shaded in warmer colors such as dark orange or red

represent locations with greater numbers of broadband providers serving an area. Areas shaded in light to dark green represent areas with five or less providers.

Map 4 - Broadband Availability (Served, Underserved, Unserved)

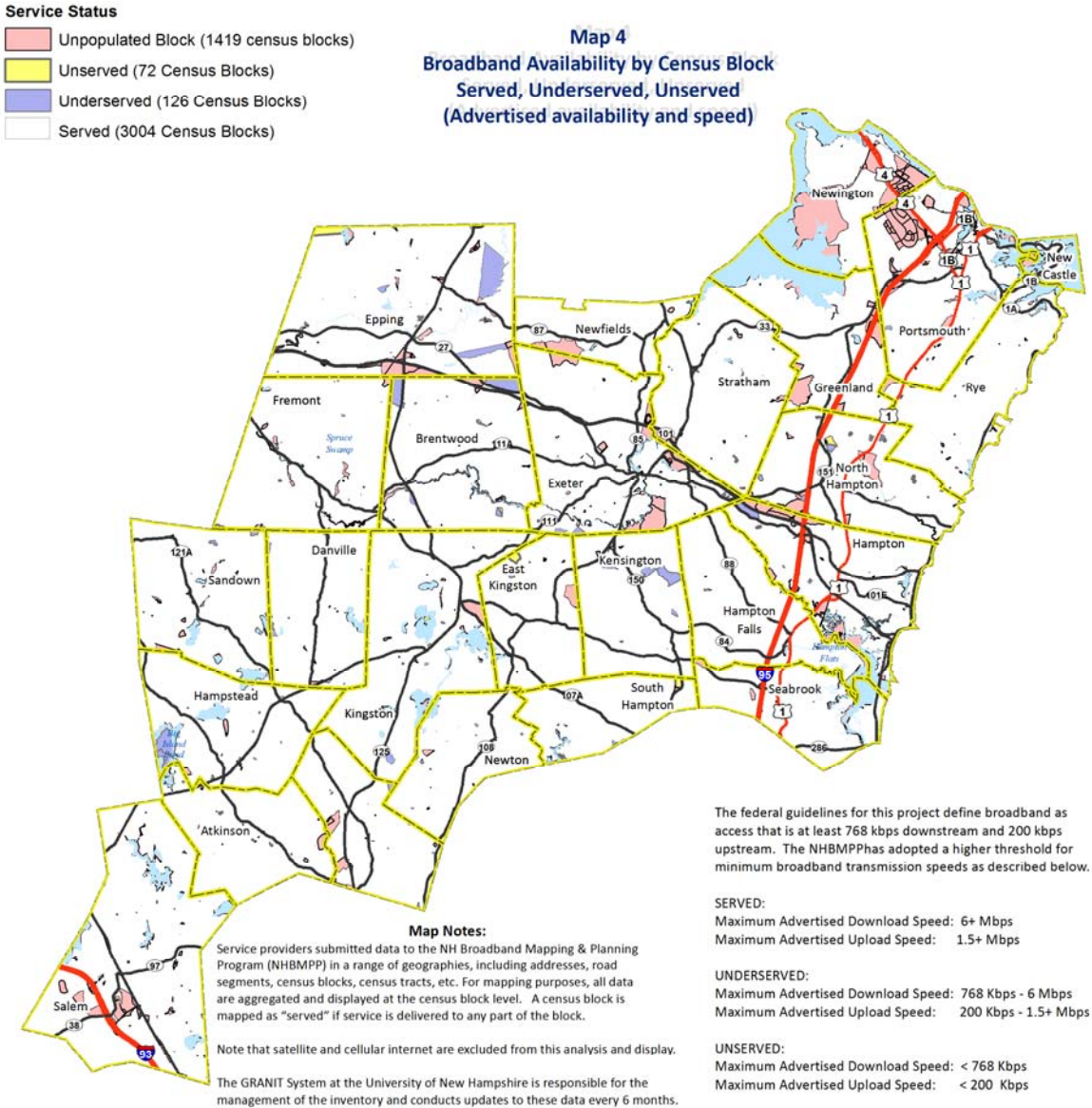

Map 4 – Broadband Availability - displays the status of available service for each census block within the RPCs planning region. Of particular concern here are the yellow and purple areas, these highlight census blocks with residences that have limited or no access to broadband. This map needs to be viewed with the understanding that this overstates the availability of broadband. Since the data is

aggregated at the block level, if one single home has access to a broadband technology, they entire block will be reflected as having access.

Map 5 - Availability of Fiber Optic Technology

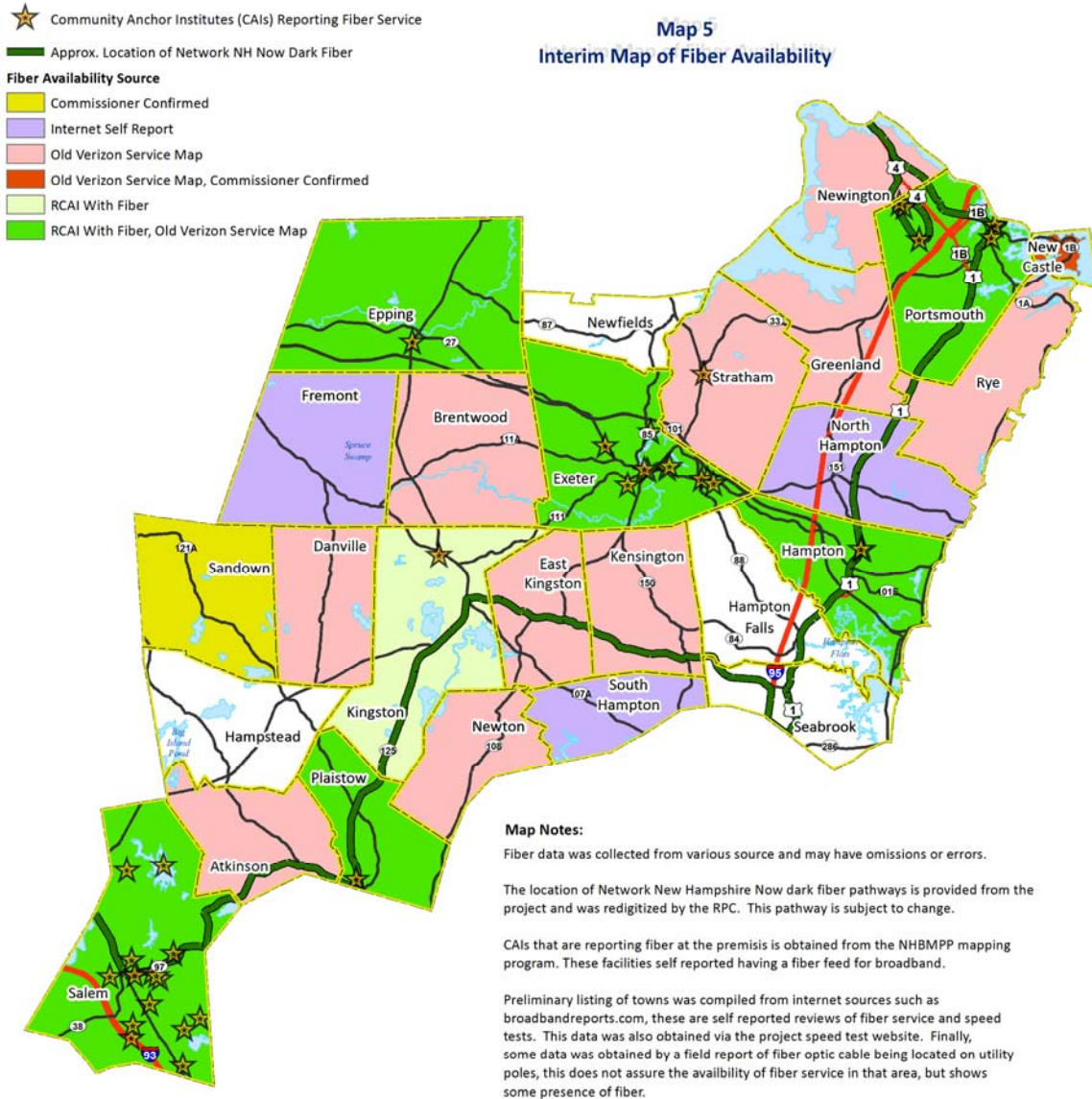

Map 5 – Availability of Fiber Optic Technology - reflects where the RPC was able to find some evidence of fiber availability exists. The RPC was not provided with much data from providers in regards to where they offer fiber optic service. The RPC used speed tests, 3rd party websites where consumers review their broadband

service, ISP websites that show maps of service areas, and some field observations of optical fiber lines that exist on utility poles to compile this map.

Map 5A – Network New Hampshire Now Statewide Map

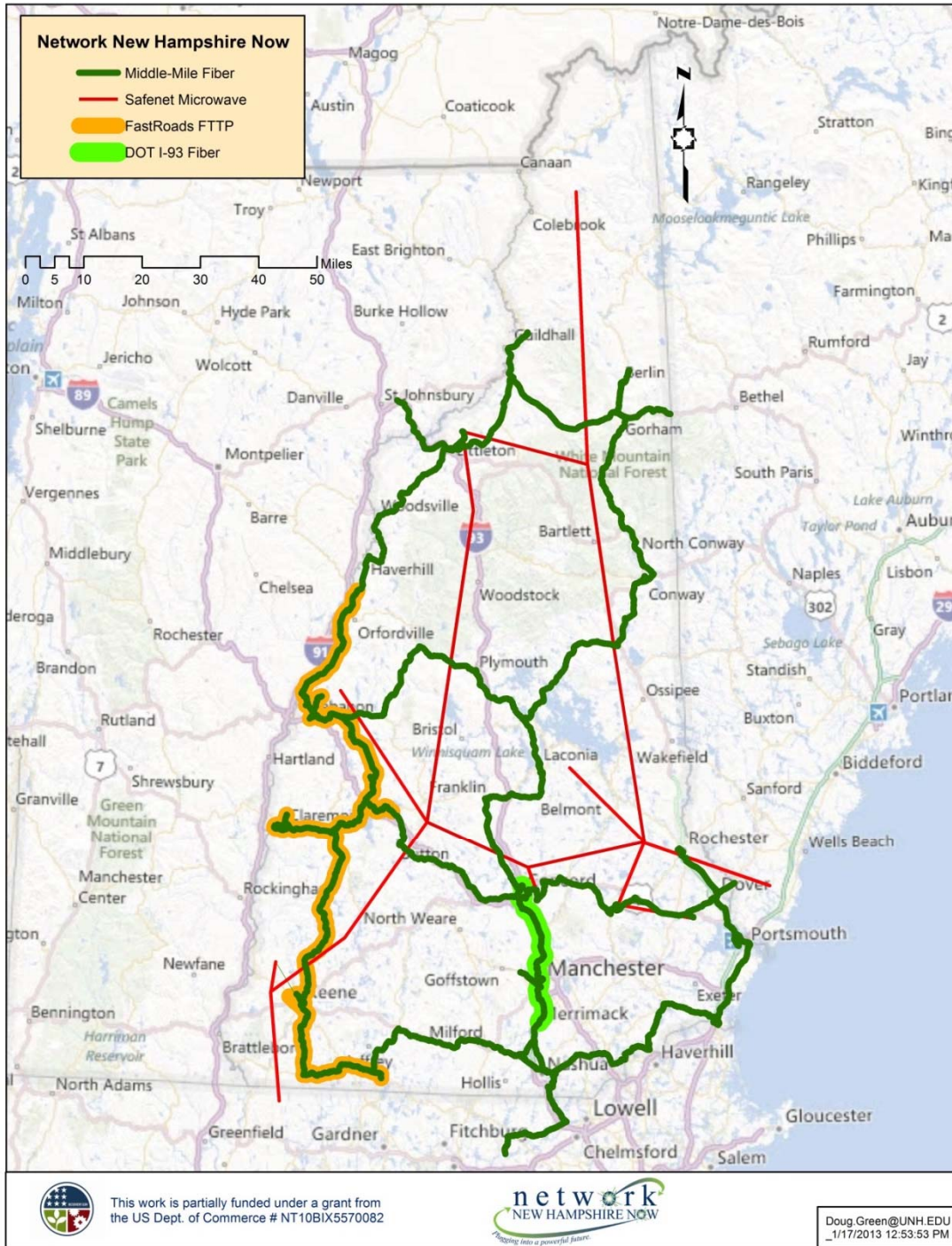

Map 5A – Network New Hampshire Now Statewide Map - is the project map from the Network New Hampshire Now / FastRoads Fiber to the Premises project. Of particular concern on this map is the green line, which show where dark fiber will be strung up as part of the project

Map 6 - Availability of Cable Modem Technology

Cable

- Cable Modem not Available
- Cable Modem Available *

Map 6
Broadband Provided via Cable Modem



Map Notes:

This map shows the census blocks where there is some access to cable modem technology. This data was compiled to the census block from base data provided to the project from ISPs. Only census blocks with residences are included.

*Note if one home in the census block has cable modem availability, then the whole block is marked as having access.

Map 6 – Availability of Cable Modem Technology - highlights where cable modem technology is claimed to be available in the region. This comes from the ISPs self-reported data and is aggregated to the Census block.

Map 7 - Availability of DSL Technology

DSL

- DSL Not Available
- DSL Available *

Map 7
Broadband Provided via DSL



Map 7 – Availability of DSL Technology - shows where DSL technology is claimed to be available. The information displayed comes from the ISPs self-reported data and is aggregated to the Census block.

Map 8 - Speed Test Results



Map 8 – Speed Test Results - reports where speed tests have been taken and which ISP the user taking the test was using. The locational data used to place the points is from a self-reported “address” that users enter when taking the speed test and is subject to error. If a user takes the speed test at work and reports their home address the location may be incorrect. The vast majority of speed survey respondents were using Comcast or Fairpoint as their provider. The speeds reported can be greatly affected by many variables at the time of the test, such as

traffic inside the users network, the node on their WAN (wide area network) and even things like viruses that may be congesting the Download and Upload of the computer. In December 2014, the RPC purchased targeted Facebook ads. These ads were used to drive users to the speedtest website. The ads ran for 14 days and were served to 38,541 unique Facebook users in our region. There were 1,357 clicks on the ads to goto the NHBMPP speedtest webpage, 1,111 of these clicks were unique. This resulted in an additional 632 speedtests of which 435 of them were unique users. The Facebook ad represented 77% of the speedtests run in the RPC region since 2010 when the speedtest page went up. Additionally, the ads garnered 14 likes, 6 comments and 12 shares. One particular note, is that 56% of the people who clicked on the ads were age 55+. These additional speedtests brought the number of census blocks represented by speedtest data from 163 to 440 total census blocks.

Facebook Ad:

Rockingham Planning Commission Sponsored · [Like Page](#)

We are studying broadband availability in NH. Click here to test your speed.

NEW HAMPSHIRE broadband MAPPING & PLANNING PROGRAM **The NH Broadband Planning & Mapping Project is evaluating broadband speeds in NH.** **ROCKINGHAM PLANNING COMMISSION**

How Fast is YOUR Internet?

Click here to be a part of the speedtest.

Download Speed 11.27 Upload Speed

How Fast is Your Internet

The New Hampshire Broadband Mapping and Planning Project is trying to collect data on the availability & speed of home internet connections in NH. This speed test will give us additional data points.

IWANTBROADBANDNH.COM

[Like](#) · [Comment](#) · [Share](#)

Broadband Access in NH by Region
Granite State Poll, April 2012

Region	Percent with Internet Access	Type of Internet Access
Western New Hampshire	89.6%	Dial-up or Satellite: 38% Broadband: 62%
Northern New Hampshire	85.6%	Dial-up or Satellite: 31% Broadband: 69%
Central New Hampshire/ Lakes Region	83.4%	Dial-up or Satellite: 30% Broadband: 70%
Seacoast Region	86.1%	Dial-up or Satellite: 25% Broadband: 75%
Central New Hampshire/ Hillsborough County	84.0%	Dial-up or Satellite: 17% Broadband: 83%

3. Regional Demand for Broadband

There have been three different types of surveys employed in developing the Plan to gauge demand for broadband in the RPC region: a 2012 statewide survey by the UNH Survey Center of small businesses, municipalities, educational institutions, and residents; and 2013 survey by the UNH Survey Center of residents in the RPC region; and through public and sector-specific engagement conducted by the RPC which included public forums held in 2012 by the RPC and a sector-based analysis conducted by the RPC in 2013. In addition, since 2010 the NHBMP has hosted a speed test tool that tests upstream and downstream data transfer rates for businesses and residents who participate in the test via the website www.iwantbroadband.org.

The RPC held three public forums in the fall of 2012, 2013 and 2014 and conducted a sector-based analysis in 2013 to gain a better understanding of broadband use and needs and deficiencies in the region. Representatives from educational institutions, the health care industry, local government, public safety, economic development organizations, and the residential sector were interviewed. The analysis was conducted through in-person meetings, focus group discussion, telephone conversations and by posing specific questions in emails.

Results of the 2012 Statewide Survey

In 2012 the UNH Survey Center conducted survey of broadband technology uses and needs of small businesses in New Hampshire. Some of the key results include the following:

- 70% of respondents use the internet for advertising
- 64% said their internet speed is sufficient
- 50% accessed the internet via cable

The Survey Center also surveyed local governments and educational institutions in New Hampshire. Key survey findings for these groups include the following:

- 55% of local government respondents said they would like to learn more about e-governance, or conducting municipal business via the internet
- 51% of local government respondents would like training on making websites interactive
- 74% of educational institutions respondents stated that their biggest internet challenge was keeping up with technology
- 59% of educational institutions responding would like to learn how to effectively use technology for teaching

A survey of residential broadband access and use in New Hampshire was conducted by the UNH Survey Center in 2012. The findings indicated the following:

- 86% of respondents had access to the internet at home
- of those 86%, seventy three percent had broadband
- Respondents indicated that the biggest barrier to broadband use was keeping up with the technology
- 31% percent of respondents who did not have internet access at home said they did not because it was too expensive
- 94% of residents stated that their internet connection is adequate for their uses

Results of the 2013 Survey of RPC Region

During May-July 2013, the UNH Survey Center conducted surveys for several regions, including the nine regional planning commissions, as part of the Granite State Future project and the NH BMPP. Several regions, including the RPC, commissioned a region-specific survey. Key findings from the survey of RPC region residents included:

- 94% of residents surveyed have internet access at home
- 75% of residents have a cable internet connection
- 30% of residents pay \$50-99 per month for internet service
- 83% of residents pay for a bundled internet service, which includes, phone, cable and internet services
- 94% of residents state that their internet access is adequate for their uses
- 87% of residents would not be willing to pay for more faster internet speeds

- Responses from residents of the RPC region were largely similar to those of statewide residents. The big difference involved what type of neighborhood residents live in, with more RPC residents living in a neighborhood close to the town center and less living in a rural location away from town.

The proprietary nature of broadband access and capacity information means that it is difficult to directly determine whether access and capacity of broadband is adequate. Based on survey results, however, it appears that most residents and business are satisfied with current levels of access, but are concern about cost and lack of competition. In summary the basic picture that emerges is that (1) the region has comparatively good access to broadband in most communities; (2) there are pockets in the most rural area of the region where broadband access is poor or non-existent except via satellite; (3) choice between providers is typically limited two companies and often just one thus limiting competition in the Broadband marketplace. Broadband speeds available in fiber and cable networks have continued to increase and appear to be keeping pace with increased demand and (4) the private and proprietary nature of broadband infrastructure information means that it is not possible to discern the condition and capacity of the system. At this point we must rely on the private providers to ensure the system remains adequate to meet the region's needs the future.

Results of NHBMPP Speed Test

The NH Broadband Mapping & Planning Program hosts a speed test on the project website (www.iwantbroadbandnh.org). The speed test tool has been active since 2010, and has collected data from over 7,500 submissions across the state. These data record the upstream and downstream data transfer rates from the user's computer to the project server and creates a snap shot of broadband transmission speeds across the state. They also provide an important mechanism to verify data reported by service providers and to help fill in missing information about broadband availability.

There may be significant differences in speeds reported between the NHBMPP tool and those that are available online and by service providers. These differences may be due to a number of variables, including volume of traffic on the network (especially for cable-based service), the age of the lines the internet service is running over, and the variability and age of the equipment (router, computer, etc.) being used. UNH has collected data from 1044 speed tests in the RPC region.

Results of NHBMPP Speed Test in the RPC Region
Source: NHBMPP, November 2013

	Geography	Speed (Mbps)	Reported ISP
Max Download Speed	RPC Region	96	Comcast Business
	Statewide	96	Comcast Business
Max Upload Speed	RPC Region	75	Harvard University
	Statewide	82	Comcast
Minimum Download Speed	RPC Region	0.113	Comcast
	Statewide	0.01	Level 3
Minimum Upload Speed	RPC Region	0.098	Comcast
	Statewide	0.006	Fairpoint
Mean Download Speed	RPC Region	17.58	
	Statewide	7.08	
Mean Upload Speed	RPC Region	7.9	
	Statewide	3.2	

ISP Reported	Number of Unique Tests	Min Download Speed (Mb/s)	Max Download Speed (Mb/s)	Avg. Download Speed (Mb/s)	Min Download Speed (Mb/s)	Max Download Speed (Mb/s)	Avg. Download Speed (Mb/s)
AT&T	2	3	23	12.8	3	13	7.9
Blue Coat Systems	1	3	3	3.3	4	4	3.7
Broadview Networks	2	5	25	14.6	9	13	10.8
Comcast	456	0	94	19.9	0	34	7.8
EarthLink	1	1	1	1.0	1	1	1.3
Excell Group PLC	1	3	3	3.0	4	4	4.0
Fairpoint	91	0	30	9.1	0	24	5.7
Granite State Communications	5	6	16	11.3	2	5	3.9
GWJ	1	3	3	2.8	1	1	0.8
Harvard University	2	13	31	22.1	4	76	40.0
Hughes Network Systems	1	5	5	5.5	1	1	0.6
Lightower Fiber Networks	1	93	93	93.2	73	73	73.4
MegaPath Corporation	1	5	5	5.0	1	1	0.6
Metro2000	1	1	1	0.9	1	1	1.2
Savvis	8	4	15	7.8	3	58	27.7
University of New Hampshire	1	4	4	3.9	3	3	3.4
Verizon	4	1	20	9.5	0	8	4.2
Viasat Communications	1	1	1	0.5	0	0	0.3
Windstream Business	1	1	1	0.7	1	1	0.6
WorldPath Internet Services	12	1	47	15.4	1	54	14.7
ZCORUM	1	5	5	4.9	1	1	1.0

RPC Sector Based Analysis

There were 20 stakeholders involved in the RPC’s sector based analysis. Participants were identified by RPC staff and members of the BSG. The following is a summary of sector analysis responses

Education

Not only does the availability of reliable broadband technology offer advances in education, it is imperative to the economic welfare and long-term success of our state and nation.²³ Participation and competition in the global economy is increasingly dependent on twenty-first century skills, including the ability to effectively use technology and navigate the digital world.²⁴ Providing access to learning opportunities that address these skills can help empower students to actively engage in an increasingly technology-driven and digital culture.

Types of Organizations	Connection Types	Sufficient for Need?	Barriers to Improved Broadband	Comments regarding Broadband in Region
Science Center (1 response), Historical Organization (1), School Administrative Units (2)	T-1, Fiber Optic, Cable	Yes but cost prohibitive (1), Yes (2), No (1)	Cost; lack of resources; inadequate internet speed; limited broadband availability; software/hardware compatibility; internet security	Would like to see more fiber offerings in the region; excellent broadband in region

Health

Many emerging technologies and approaches to health care are dependent on broadband connections to improve health care outcomes while also controlling costs and extending the reach of health care providers.²⁵ Individual patients, providers, and the overall public health of a community benefit from more efficient, innovative, and informed health care systems as new technologies are adopted.

²³ Federal Communications Commission, *Connecting America: The National Broadband Plan*, 2010, http://www.broadband.gov/plan/11-education/#_edn16. (accessed July 17, 2013).

²⁴ Charles M. Davidson and Michael J. Santorelli, *The Impact of Broadband on Education*, A Report to the U.S. Chamber of Commerce, Dec. 2010, http://www.uschamber.com/sites/default/files/about/US_Chamber_Paper_on_Broadband_and_Education.pdf. (accessed July 2013).

²⁵ Federal Communications Commission, *Connecting America: The National Broadband Plan*, 2010, http://www.broadband.gov/plan/11-education/#_edn16. (accessed July 17, 2013).

Types of Organizations	Connection Types	Sufficient for Need?	Barriers to Improved Broadband	Comments regarding Broadband in Region
One organization operating health clinics, a home health agency, a major hospital, and several physician practices;	Fiber Optic	Yes	High cost	More provider competition is needed to lower cost; third party vendors all use Fairpoint for last mile but Fairpoint does not provide third parties with as good a service as direct customer

Local Government

Undoubtedly, certain matters will always be best handled through face-to-face contact and technology should augment New Hampshire’s tradition of accessibility to the public process. But citizens have come to desire, and sometimes expect, a certain level of online interactivity with government and community support organizations. Most towns in New Hampshire currently host websites providing immediate, remote access to public notices, events calendars, applications, forms, ordinances and regulations. While constituents benefit from easy access to the information they need, governments and community support organizations save time, money and resources when routine requests are handled online.

Types of Organizations	Connection Types	Sufficient for Need?	Barriers to Improved Broadband	Comments regarding Broadband in Region
Municipalities (3); Public Library (1); Regional Planning Commission (1); Land Trust (1)	DSL, Fiber Optic, Cable	Yes (5), No (1)	Lack of resources; software/hardware compatibility; staff training; awareness of technology options; rapidly changing technology; internet security	Cable successful, but problematic in rural areas; broadband adequate and growing

Public Safety

Broadband access through a combination of wired and wireless technologies can enhance public safety by enabling first responders to make informed decisions and allowing them to communicate with one another effectively, usually resulting in reduced loss of life and property.

Types of Organizations	Connection Types	Sufficient for Need?	Barriers to Improved Broadband	Comments regarding Broadband in Region
Municipal Police (2); Municipal Fire (3); Emergency Management (1)	Cable, T-1, Fiber Optic	Yes (4), Unknown (1); Fixed access, yes, mobile access via cell, no (1)	High cost; limited availability; lack of IT support; software/hardware compatibility; synching multiple devices; internet security; insufficient network redundancy; lack of staff training; rapidly changing technology	Adequate (1); Improving (1); Lacking (1)

Economic Development

The use of broadband for economic development improves the ability to retain and recruit businesses, increases business profitability, attracts highly skilled workers, improves the efficiency of municipal services, enhances access to healthcare, and contributes to stronger educational attainment. All are key ingredients to a successful economic development strategy.

Types of Organizations	Connection Types	Sufficient for Need?	Barriers to Improved Broadband	Comments regarding Broadband in Region
Regional Economic Development Agency (2); Regional Chamber of Commerce (1)	Cable (2); Fiber Optic (1)	Yes (2); Sufficient for now but future (1)	Lack of resources; awareness of technology options; support and staff training	Broadband is adequate for region but cell service is not; need expansion of fiber to more businesses

F. Challenges to and Opportunities for Regional Broadband Development

1. Barriers and Opportunities

Over the course of several of its meetings in 2011 and 2012, the RPC Broadband Stakeholder Group (BSG) discussed and identified barriers to deployment and expanded access to broadband service in the region. Each region in New Hampshire faces different but comparable areas of needs and barriers to meeting those needs. The RPC region enjoys a very high level of residential access as measured by the percent of population identified in the mapping component of this project. However, gaps do remain, especially in the least densely populated areas of rural communities. Although these gaps do not always appear in the broadband mapping because of the Census block limitations, we are aware that there are numerous residential addresses in the lowest density Census blocks in the region that do not have broadband service. Achieving conventional wire-line broadband access to all of these unserved locations through private sector carriers will continue to be a challenge due to low or negative return on investment of broadband deployment in low density areas. Other perceived barriers exist in the form of providing superior bandwidth rates to commercial users, regulatory issues, and a perceived lack of competition among broadband providers.

The following list of political/regulatory, economic, social, and technological barriers related to commercial and residential broadband in the region was developed by the RPC BSG:

Political/Regulatory Barriers

- *Regulatory Concerns* - Cable/internet providers do not fall under the purview of the Public Utilities Commission. Broadband providers do not want internet service to be considered a utility as they would face increased regulation under the Public Utilities Commission. While cable TV access franchises are subject to negotiated agreements with individual municipalities, the broadband/internet component of the service is not and is therefore is not part of formal franchise service negotiations with municipalities between providers.
- *Deployment Difficulties* - Deployment may be cost-prohibitive. Securing pole attachment rights can be time consuming and costly and sometimes abetted by competitive conflicts may impede service expansion and choice. The BSG learned that in the 2012 legislative session, HB 1391 aimed to eliminate barriers to deployment. The legislation is currently with an interim study committee of the legislature. The NH Legislature did pass SB 48 in the 2012

session and the law was signed by the Governor. The legislation aims to deregulate some aspects of the process.

- *Cable Franchise Agreements* - An impediment to increased competition (and thus service and choices) may be related to Cable Franchise Agreements. Alternative broadband providers are often in direct competition with cable providers under agreement with municipalities. Municipalities need to be educated and empowered when it comes to negotiating Cable Franchise Agreements, and proactive in improving local service.

Economic Barriers

- *Inadequate Access for Commercial Applications* - While the RPC region has better coverage than many parts of New Hampshire, the Regional Economic Development Center (REDC) still receives complaints from businesses stating that greater bandwidth and improved technology infrastructure are needed in the region. Anecdotally, it is thought that some industrially-zoned properties go underutilized due to the distance of "last-mile" connections and the cost of obtaining high speed access. Further, the level of service required by technologically demanding business in the foreseeable future could potentially outstrip the planned build-out of broadband services in the region.
- *Economic Constraints* – The capital investment required to provide broadband service in areas with low population densities may not be feasible because the return on investment is too low. Additionally, some providers appear to be focusing on expansion of wireless broadband services rather than wired infrastructure, indicating it may be the more lucrative investment. This may also be seen as a positive since wireless towers typically utilize a fiber-optic connection and can provide reasonably high speed service (though not comparable to wired service) to users where last-mile connections are cost-prohibitive. Alternative economic models (e.g. municipal or neighborhood association financing) to provide last mile connections exist but are in some cases discouraged by existing providers.

Social Barriers

- *Complacency* – As noted in the 2013 UNH survey of RPC region residents, there is a sense that our region is adequately served and prepared for the future. Throughout the planning process we have observed there is some lack of concern about broadband access. The perception is that, by and large, broadband access and speed are adequate, and, while lack of provider competition is a concern, the consequence of that in terms of cost of service is not yet perceived as a major problem.

Technological Barriers

- *Infrastructure Information* - In order to understand future network expansion, the large commercial broadband users need to understand the existing broadband infrastructure, and its ability to meet future needs. The BSG has expressed a desire to have better information relating to the location of broadband backbone infrastructure as well as existing and potential bottlenecks. This information is available from public providers (such as NH Now) but is considered proprietary by the private providers and unavailable to us or users.

The RPC BSG also discussed opportunities to improve broadband access and adoption. The group identified the following opportunities in the region:

- *Public/Private Partnerships* – A guidance document to help communities and neighborhoods understand the potential to partner with service providers to extend lines into underserved areas of the community. A revolving loan grant program may support such an initiative.
- *Service Expansion Grants*: Explore grant opportunities to extend service/capabilities in underserved neighborhood/communities.
- *Regional collaboration*: Bundle a larger numbers of users to leverage increased investment and responsiveness from existing service providers to enhance their offerings.
- *Publish Accurate Service Maps*: Accurate service maps may show providers the potential savings by displaying accurate service regions (less wasted advertising to areas with no infrastructure), provide customers with information on the extent (or lack of) service.
- *Community Master Plans*: Develop a broadband-specific chapter into local and regional master plans to help with understanding of zoning for broadband infrastructure and awareness of broadband as critical infrastructure for economic development and quality of life.
- *Legal reform*: Identify regulatory issues, such as pole attachment, and work to resolve those within communities where possible.
- *Local Technical Assistance*: Develop a regional white paper for communities in the region to help local decisions makers better understand how to foster broadband through franchise agreement and other means.
- *Broadband Technological Opportunities Program (BTOP)*: Ensure there is availability to expand or ensure there is adequate coverage of business quality broadband infrastructure, including regional access to fiber capacity implemented through the NH BTOP.

2. State and Local Initiatives

In 2008, the State of New Hampshire Department of Resources and Economic Development (DRED) and the Telecommunications Advisory Board (TAC) released the State of New Hampshire Broadband Action Plan. The Plan was developed after the authors held five regional, public forums, interviewed key stakeholders throughout the state, completed two questionnaires targeting broadband providers and users, and researched the status of broadband in five other states.

The Plan recommended twenty five actions to be taken to improve broadband access and adoption rates. The actions are summarized as follows:

- Broadband is critical infrastructure for both businesses and citizens.
- The State of New Hampshire is well positioned to compete in the New Economy when compared to its more rural neighbors.
- Leadership on broadband issues can be improved and the State needs to evaluate the feasibility of creating a centralized, leadership function to ensure broadband initiatives and projects are well coordinated.
- State government has opportunities to realize cost savings and alleviate budget challenges by increasing the utilization of broadband technologies such as video conferencing.



Working with University Systems of New Hampshire (USNH) and Network New Hampshire Now (NNHN); New Hampshire Optical Systems (NHOS) has developed an initial network model that supports the goals of the National Telecommunications and Information Administration (NTIA) and Broadband Technologies Opportunities Program (BTOP) for service to underserved and un-served areas of the state while at the same time building additional infrastructure in areas already with broadband availability. The result is the creation of an open access, non-discriminatory platform offering broadband providers the ability to economically expand their services areas, companies the opportunity to build private networks they own and control, and users more choice and affordability in their Internet access and communications products.

By Selecting NHOS, the State of NH simplifies many aspects of this project. It affords the State the ability to work with one vendor who is skilled in many different areas and can see the project to completion. The design, construction, and long term care of a network like this can have a myriad of moving parts. NHOS provides that single point of contact in a robust solution like this one, so that the project stays on track and is properly managed. The NNHN Middle Mile project is over 750

miles of fiber construction, design, and maintenance. This was awarded to NHOS in the summer of 2011 and was completed June 2013.

The New Hampshire middle mile network will form a statewide broadband technology corridor for decades to come. Demand for information transport has grown exponentially in the last decade and shows no sign of abating. In fact, projections show this growth accelerating. To meet this challenge, New Hampshire Optical Systems (NHOS) embarked on an aggressive design-build schedule that delivered the first operational segments before the end of 2011. By July of 2012 more than half of the middle fiber was installed with the entire network planned completed June 2013. The "FastRoads" project is an extension of the NNHN project to provide fiber to the home and truly completes the vision of the State. This was also awarded to NHOS and is now complete. Other projects like the microwave opportunities are already set to ride over NHOS fiber network.

In the RPC region, the Regional Economic Development Center of Southern New Hampshire REDC) is responsible for producing an annual Comprehensive Economic Development Strategy referred to as CEDS. To develop the CEDS, the REDC works with a broad and diverse group of leaders in the region, including representatives from major industries, municipal officials, the RPC, and small and medium-sized businesses. REDC submits the CEDS to the US Department of Commerce, Economic Development Administration.

Goals and objectives outlined in the CEDS include economic development, infrastructure development, regional cooperation, workforce development, workforce housing, and environmental preservation. Broadband is specifically mentioned as a goal in the 2013 CEDS: "To invest in infrastructure improvements, such as roads, bridges, sewers, water facilities and broadband, and multi-modal transportation systems that will strengthen and diversity the regional economy."

G. Findings and Recommendations

In the RPC region, there is a low level of interest in broadband access. Concerns lie primarily with the costs associated with broadband service and the lack of competition among providers more than the level of service. There are small areas across the region that are not served by broadband and that is of concern. The current regulatory framework does not enable public involvement in the broadband contract negotiation process as it does with cable franchise agreements.

1. Evaluation and prioritization of needs/challenges/opportunities

The BSG developed the following description of understood broadband needs for the RPC region:

- *Better Bandwidth and Understanding of Availability of Broadband* - Regional Economic Development Center (REDC) still receives complaints from businesses that greater bandwidth and improved technology in infrastructure are needed. This may be due to a lack of understanding of availability and understanding of how to gain access to existing capacity.
- *Infrastructure Information* - In order to understand potential network expansion, the BSG needs to understand the existing network of infrastructure, including location of "trunk-lines" and existing and potential bottlenecks. As part of this increase in location of networks, there should be consideration for the providers to have a more transparent 'service map' for consumers to know which providers are available in their locations.
- *Increased competition for service providers* –Consumers seem to have little or even no choice in providers. Within our regional there is at best a duopoly, and in some cases a monopoly of broadband service providers based on location.
- *Broadband to be Understood as a Basic Utility* – Broadband needs to ascend to the 'basic utility' status of telephone service and electrical service. This may be accomplished through public policy such as the Rural Electrification Act of 1936, Communications Act of 1934 and the Universal Service Act of 1996.
- *Ease of Pole Attachment process* –Time, cost, ownership of poles and how fees will flow from one entity to another seem to be a significant barrier towards an expansion. The need to simplify the process to allow pole attachments seems critical to any expansion of broadband service.
- *Peak response requirement* – Broadband providers should have a peak response requirement similar to electric utilities.
- *Internet as a regulated utility* – The BSG feels there may come a time in the development of internet service when it needs to become a regulated utility to monitor if the service is being provided in a cost effective way.
- *Internet included in municipal franchise negotiations* – Municipalities currently negotiate franchise agreements with cable providers and internet service should be included as part of the negotiations to enable public participation.
- *Stay Current with Technology* - Encourage existing providers to keep up with current technologies so that the region benefits from progress

H. Implementation

Implementation of the strategies recommended in this Plan will require planning and partnerships between all levels of government, economic development organizations, utilities and service providers.

To measure the success we make as a region towards implementation the RPC has selected for critical areas which need to be addressed to improve broadband. These areas are identified in a 2013 report from the UNH Broadband Center of Excellence, "Broadband 2020: Achieving Ubiquity", and are as follows:

- Availability – What percentage of people, residences and businesses have access to broadband service in a given area?
- Adoption – What percentage of these potential users are actually connected to an available broadband service?
- Affordability – In a given area of coverage, how comfortable can an individual or family with average income pay for available broadband services?
- Performance – What is the bandwidth (bit rate), of the broadband service to and from the end user?

The following strategies and actions are the result of research and discussion by the nine regional planning commissions and their respective Broadband Stakeholders Groups, UNH Granit, and the Office of Energy and Planning.

1. Identification of Prioritized Strategies, and Actions, Timeframe and Responsible Parties

Expand access to affordable broadband service

- Develop program to offer affordable internet and access to computers for underrepresented populations, veterans, home-based business owners, etc. similar to the Comcast Internet Essentials Program (<http://www.internetessentials.com/>).
- Expand use of and access to existing programs offered by services providers to increase access to computers, and broadband for youth and underrepresented populations.
 - Ex. Comcast Internet Essentials program offers reduced service rates and purchase prices of computers for families qualifying for free or reduced lunch.
- Expand existing and develop new free or low cost, public Wi-Fi networks.
 - Facilitate conversations with industry experts, local communities and sector stakeholders around the development of public Wi-Fi networks.

- Work with schools systems to encourage expanded access to affordable broadband technology/high speed internet.

Broadband Use

- Expand and develop opportunities for education around broadband use.
 - Look to community education institutions like colleges to offer workshop or training.
 - Look to existing training programs that involve parents/teens in shared learning experiences as a model.
- Work with the NH Municipal Association to promote or sponsor education / training/ other opportunities around broadband capacity building for municipalities.

Cable Franchise Agreements

- Develop guidance for communities for negotiating CFA process.
 - Ex. In southern NH there is an 11 Town consortium that formed to share resources for navigating the CFA negotiation process.
- Establish resources for RPCs and others with information to better understand the components/legalities of and process for negotiating CFAs.
- Explore development of training program / capacity building opportunities around education/guidance on CFA negotiation (potentially through UNH CE, NH Municipal Lawyers Association, NH Municipal Association, Citizen Planners, others?)
- Update existing web resources on topic to contain most current information.
- Investigate potential strategies to encourage and enable inclusion of access to internet service in CFAs.
- Establish model CFA for communities to use in negotiating or renewing CFA.

Broadband Committees & Stakeholder Groups

- Promote the development of municipal telecommunications or broadband committees.
 - Develop how-to guide for municipalities to develop broadband committees.
 - Develop resource materials to assist work of local broadband committees.
 - Encourage establishment of enabling legislation for these committees
- Explore possible funding opportunities for sustaining staff support to regional broadband stakeholder groups past December 2014.

Resource Clearinghouse

- Develop clearinghouse of information (web-based), reference materials, & meeting minutes, etc. for business owners, legislators, others to stay informed of regional and local efforts around planning for broadband (would include links to resources within and outside region).

Municipal Broadband Master Plan Chapters

- Develop guidance materials and training programs for towns on creating and adopting broadband components to municipal master plans such as broadband chapters.
 - Ex. Sanbornton has developed Telecommunications Advisory Committee to advise Planning Board in development of Broadband Chapter to Master Plan.
- Develop model broadband chapter to master plan for use by communities.

Funding

- Promote establishment of dedicated funds for broadband at the municipal level.
 - Ex. Moultonborough established Community Technology Fund 6 years ago, which will have +/- \$180,000 in it by year's end.

Fiber to the Home

- Identify and document the importance of developing open access fiber networks to the premise or projects similar to NH FastRoads.
- Include the need for expanded fiber infrastructure as a priority project in regional CEDS and other important planning documents.
- Explore opportunities/strategies for encouraging development of fiber to the premise in underserved areas.
- Identify what actions/strategies need to occur to expand open access fiber networks such as NH FastRoads.
- Promote strategies to fully utilize existing fiber infrastructure within the Region.
- Explore potential market/economic barriers to full utilization of existing or developing new fiber infrastructure.
- Work with partners at state and local levels to improve the public dataset of information on the location of existing fiber infrastructure.
- Compare the cost effectiveness / feasibility of solutions that promote fiber to the end user with other fixed wireless/wireline technologies.
- Explore opportunities for promoting a multi-technology approach to expanding broadband availability.

Continue Mapping & Data Collection Efforts

- Support continuation of the NH Broadband Mapping program efforts to collect, analyze and map broadband information from providers and community anchor institutions across the state.
- To encourage providers to make available information on the location of fiber infrastructure
- Explore innovative methods for acquiring information on the location of broadband (link broadband availability to property assessment at local level)

- Revisit requirements of service providers to share information with the NH Office of Energy and Planning in NH RSA 12-K, Deployment of Personal Wireless Service facilities.
- Support efforts to expand coverage of LIDAR data statewide.

Regulatory Barriers

- Support initiatives to address regulatory and / or policy barriers to broadband expansion.
- Encourage legislators to support legislative amendments seeking to enhance municipalities' ability to bond for broadband infrastructure.
- Conduct audit of local land use regulations to identify barriers to broadband deployment.

Resiliency of Broadband Infrastructure

- Ensure that existing and new broadband infrastructure is resilient and redundant.

Broadband as Critical Infrastructure

- Encourage inclusion or consideration of broadband in hazard mitigation or recovery planning as part of response plans.
- Identify strategies to galvanize interest or concern of municipalities for improved broadband (i.e. ways to prevent complacency).
 - Communicate / highlight the benefits broadband provides to multiple sectors (health, education, public safety, etc.)
- Undertake economic impact study that examines the costs/benefits/economic value of varying broadband technologies to property owners.
 - Include conducting such a study as recommendation in CEDS, and other planning documents.
 - Study could be used as tool to support argument for broadband expansion at public meetings, town meetings, etc.
- Explore the possibility of incorporating access to broadband as part of property assessment at local level.
- Explore case studies or examples of how other states have addressed broadband as critical infrastructure.
 - What strategies were taken to achieve this goal?
- Include broadband plans as part of RPC regional plans.
- Encourage telecommuting.
- Consider legislative measures to help pay for universal access such as the Universal Service Fund of 1996 for telephone service.

State Broadband Authority

- Explore development of state broadband authority that would oversee a funding component to encourage expansion of broadband efforts at regional and state level.

- Examine models provided by other states for establishing a state broadband authority.
 - Ex. Maine, Vermont, Connecticut and Massachusetts are New England states that have established authorities

2. Implementation Matrix

Priority Ranking	Phase	Strategy	Level of Action	Implementation Lead*	Potential Partners	Measures of Success*	Notes
Higher	3-5 years	Coordinate with all providers to develop a service map, including proprietary information from private providers.	Federal State	Government	Internet Service Providers (ISPs) RPC	Availability	No current requirements or incentives for ISPs to provide information
	3-5 years	Encourage inclusion of broadband in hazard mitigation and recovery/response planning	State Region Local	Public Safety Government	Municipalities RPC State	Performance	
	3-5 years	Encourage municipalities to negotiate internet service as part of cable franchise agreements	Local	Government	Municipalities Utilities RPC OEP UNH	Availability Affordability Performance	
	3-5 years	Encourage policies that promote the installation of broadband conduit when construction occurs in roadway rights of way	State Local	Government	RPC	Availability	
	5+ years	Ensure a high level of service to all areas in the region	State Region	Government	Municipalities DRED PUC Federal	Availability	PUC involvement based on long-term perspective of broadband being regulated as a utility
	5+ years	Encourage competition among broadband providers	Federal State Local	Government	FCC PUC	Affordability Performance	PUC involvement based on long-term perspective of broadband being regulated as a utility
	5+ years	Ensure ISP capacity planning is adequate to serve future needs	State	ISPs	Federal State PUC ISPs	Availability Performance	PUC involvement based on long-term perspective of broadband being regulated as a utility
	5+ years	Ensure broadband network is sufficiently resilient and redundant to serve in times of crisis	State	ISPs	Federal State ISPs	Availability Performance	
	5+ years	Simplify the process to allow pole attachments	Federal State	Government	PUC Utilities	Affordability	
	Ongoing	Support programs that provide internet access to underserved populations	State Region Local School Districts	Government Private Sector	Utilities School Districts ISPs Municipalities Libraries	Affordability	
	Ongoing	Innovate and utilize financing mechanisms to improve broadband access	State Region Local	Government	Municipalities REDC State	Availability	Examples of financing mechanisms available from MA and VT

Priority Ranking	Phase	Strategy	Level of Action	Implementation Lead*	Potential Partners	Measures of Success*	Notes*
	Ongoing	Support the development and adoption of local master plan chapters that describe broadband service and needs	Local Region	Government	Private Sector Municipalities RPC REDC CEDC	Availability Adoption Affordability Performance	
Medium	1-3 years	Raise awareness about the status of broadband in the region through promotion of the State and Regional Broadband Plans	State Region	Government	RPC	Availability Adoption Affordability Performance	
	3-5 years	Promote the establishment of municipal broadband committees	Local	Government REDC	Municipalities	Availability Adoption Affordability Performance	Committees can function separately or be part of municipal cable committees
	3-5 years	Support continuation of NH Broadband Mapping Program	Federal State Region	Government	RPC UNH ISPs	Availability	Only worthwhile if ISPs provide better data resolution
	Ongoing	Provide outreach and education to municipalities and economic development leaders on current and future broadband issues	Local Region	Education Government Economic	Municipalities REDC RPC UNH OEP DRED	Adoption	
Lower	1-3 years	Support development of activities by the state and UNH to provide resources for broadband users	State	Government	UNH DRED	Availability	
	3-5 years	Explore development of a state broadband authority designed to oversee funding to encourage expansion of broadband	State	Government	UNH	Availability Performance	

*** Matrix Key**

Measures of Success

Based on UNH Broadband Center of Excellence Report, "Broadband 2020: Achieving Ubiquity", November 2013

Implementation Lead

Sector where strategy is implemented.

J. Appendices/Resources

New Hampshire Broadband Mapping Protocol

Prepared By: NHBMPP, September 2013

Introduction

The New Hampshire Broadband Mapping & Planning Program (NHBMPP) is funded through the Department of Commerce's National Telecommunications and Information Administration (NTIA) State Broadband Initiative (SBI), formerly known as the State Broadband Data Development (SBDD) program. In 2010, grants were issued to each of the 50 states, 5 territories and the District of Columbia to compile and maintain a mapped inventory of broadband availability at the state level. The state data sets are regularly submitted to the NTIA for incorporation in the national broadband map, thereby contributing to national, regional, and state efforts to understand the current broadband landscape and to plan for future broadband expansion, access, and adoption.

Broadband Availability

The NHBMPP began mapping statewide broadband availability in January of 2010, with data collection and processing scheduled at 6-month intervals throughout the project end date of December 2014. All map data development is governed by NTIA guidelines and standards, which are enforced to accommodate the merging and analysis of data from NH with comparable data sets from the other 55 grantees.

The first NHBMPP mapping task was to generate a listing of the active internet service providers (ISPs) in the state. An initial list of approximately 70 ISPs was compiled from existing plans and documents as well as local knowledge. The list is continually reviewed and updated as required, and currently includes over 60 known active providers.

At the start of each biannual map update, NHBMPP staff contacts each active ISP and requests broadband service coverage information. The data requested by the NHBMPP comprises the footprint of the provider coverage area(s), the technology delivering service to that footprint, and the advertised download and upload data transmission speeds for the footprint. Per NTIA guidelines, the footprint represents both areas that are currently served and areas that could be served within 10 business days.

NHBMPP focuses on building strong relationships with providers, and actively encourages the provision of data by accommodating data submissions in a variety of forms, and by providing technical support to facilitate submission when requested. The coverage data received by the NHBMPP arrives in formats ranging from detailed maps with speed information to customer addresses to highlighted paper maps to full digital databases that align with the national broadband map format.

The ISP data submissions are processed by the NHBMPP, standardized to conform to NTIA programmatic requirements, verified with the providers, and submitted to

NTIA during the spring and fall of each year. Key details of the data processing and standardization include:

- Wireline broadband technology (cable, DSL, T-1, fiber) data are processed into the NTIA standardized format of US Census blocks for areas where the blocks are less than two square miles, and US Census road centerlines for rural areas where the census blocks are greater than two square miles. (The US Census data are derived from the 2010 TIGER files.) If a provider indicates that an address within a Census block or along a road segment is served, the entire block or road is considered served. This may result in an overstatement of coverage footprints in some areas of the state.
- Coverage footprints may also appear to be overstated due to the fact that some providers are submitting data on residential and business class services combined, without differentiating between the two classes. This means that the speed associated with a given census block may reflect the high-speed services delivered to businesses within that block rather than typical speeds available to residential customers. This is more likely to result in an overstatement of speed tiers achievable than it is an overstatement of the coverage footprint itself.
- Wireless broadband technology (cellular, fixed-wireless, satellite) data are processed to represent the actual region that the signal covers. For cellular and satellite providers, the provider submission to NHBMPP is typically the coverage footprint. For fixed wireless, the submission typically comprises the tower location and height, and associated antenna details (make, model, power, signal direction, and span). The NHBMPP then utilizes specialized software (Cellular Expert) to process these inputs and to generate a signal propagation model describing the coverage area.
- Providers are submitting maximum advertised download and upload streams to the NHBMPP, as per NTIA guidance. The NHBMPP recognizes that these may be higher than actual speeds experienced by consumers. However, the NHBMPP verification efforts detailed below, and specifically the collection of speed test records, helps to mitigate this issue.
- The NHBMPP invites participation from all providers. However, not all ISPs have opted to submit data in each data collection cycle. This may result in an understatement of coverage footprints for some areas and some technologies.

While the NHBMPP is required to process the coverage information in the aggregated format, each state does have the opportunity to advance and enhance the level of mapping locally. The NHBMPP collects a suite of complementary data in order to verify the service information supplied by the ISPs. These include user speed tests submitted to the project website (iwantbroadbandnh.org), broadband use and availability surveys also submitted to the project web site and/or collected at project meetings, and direct email feedback. The program has also conducted a number of technology-focused verification inventories, including the following:

- Statewide drive test to collect cellular service data. In the summer of 2012, every US interstate and state route in New Hampshire was driven and each of the 5 cellular provider networks was tested for a data signal using signal propagation software on a provider cell phone.
- Town verification maps to provide feedback on the wireline technologies service areas (DSL and cable). In the summer/fall of 2013, paper maps were provided to each of the 234 cities/towns in the state, requesting that community members with knowledge of the broadband landscape review and submit corrections to the NHBMPP, as appropriate.

Where any of these verification methods indicates that service may not be available in an area reported as served, that area is marked for additional inquiry. Direct contact with the appropriate provider is made to confirm that the mapped data are correct based on project standards. If the finding is that the block is appropriately mapped but there are interior service gaps, the census block (or road segment) is flagged as being partially served. In some cases, broadband service to NH residents was offered or improved based on these reports and direct provider feedback.

Community Anchor Institutions

Broadband connectivity information for New Hampshire's 4,000+ Community Anchor Institutions (CAIs), including schools, libraries, municipalities, hospitals, and public safety entities, is collected on the same biannual schedule as the broadband coverage data. At the project outset, the nine regional planning commissions (RPCs) compiled listings of each CAI in their jurisdiction, mapped their location, and conducted phone and email surveys with each institution. Since that time, the broadband connectivity information collected has been updated and maintained every 6 months through utilization of a web based reporting tool, as well as direct contact by the RPCs to the CAIs. As recently reported by NTIA, these data have been used by policymakers, researchers and other stakeholders, as well as the Network NH Now broadband expansion project, in planning for broadband expansion in NH and nationally.

Data Management

All of the data collected as part of the inventory and verification process are managed in a geographic information system (GIS), which allows for extensive data analysis and reporting. These data are analyzed in concert with other spatial data available in the GRANIT database in order to identify areas of the state that are served, unserved, and underserved. Due to the ever-changing speed requirements of online applications, areas of New Hampshire that are designated as underserved are subject to ongoing review.

The data collected by the NHBMPP and its partners are available in multiple venues. Key data sets of broad interest may be downloaded through the GRANIT web site (www.granit.unh.edu). Other data may be requested directly from the NHBMPP

(contact@iwantbroadbandnh.org). In addition, the basic broadband availability data and the CAI inventory are available for online viewing through an interactive map hosted on the NHBMPP website (www.iwantbroadbandnh.org).

Through direct provider contact as well as community engagement and feedback, the NHBMPP has been able to generate the most accurate and comprehensive broadband inventory available to date. Additionally, this engagement has increased the dialogue between stakeholders on resolving issues around broadband availability, accessibility and adoption.

However, the NHBMPP recognizes that in some cases, broadband access and adoption is more a matter of affordability than one of availability. While pricing information is not currently being inventoried, steps have been taken to collect these data and efforts will continue in the future.

In addition to the coverage data currently being collected, rural address points are also being inventoried across the state, and will be publically available to support more granular level mapping in the future. These data may be used to inventory specific addresses for their broadband availability in order to pinpoint those areas of the state with no service or when service is limited. Collecting the speed tests at the address level will yield a higher resolution of mapping in order to identify the gaps in service in the census block.

The NHBMPP has developed the matrix below to assist in understanding the diverse levels of broadband available in the state today, and the typical functions a user might be able to perform within a range of download and upload speed tiers. Using these tiers, the NHBMPP has established broadband availability categories (“served”, “underserved”, and “unserved”) to describe access to broadband service. These categories are based solely on the maximum speeds available to the end-user or end-device. While some states are also considering the number of providers servicing a given area when determining access levels, e.g. a degree of competition, the NHBMPP has not chosen to incorporate those analyses in this availability category distinction.

When using the matrix to evaluate access, determine the category by assessing both the download and upload speeds. Most broadband technologies (cable, wireless, satellite, etc.) are not capable of sending and receiving data at the same speed, with upload speed typically being more limited.

As broadband functions, applications and technologies are continually changing, these analyses do not seek to supersede other national and/or state efforts to establish a standard definition for “broadband”. Only 15 years ago, a 56 kbps connection was sufficient to conduct most business on the internet. Today, in order to use many internet applications successfully, a minimum download speed of 3 mbps is required. This trend towards increasing requirements for bandwidth capacity will certainly continue into the future, and the matrix of uses presented herein will evolve as well.

The Future of Mapping Broadband in NH

At the conclusion of the NTIA-funded program in 2014, responsibility for national broadband availability mapping will transfer to the Federal Communications Commission (FCC). Currently, there is a federal requirement for providers to submit to the FCC their service information at the US Census tract level. Starting in 2015, the FCC requirement will change to reflect the US Census block level geography that has been used by the NHBMPP and its counterparts around the country.

The NHBMPP hopes to secure funding and resources to continue this important broadband inventorying effort. One key data stream that we hope to continue is the collection of speed test data, as this represents actual speeds experienced by users around the state. These data may then be able to enhance the census block information collected by the FCC in order to indicate the areas in which actual transmission speeds experienced by users are lower than those reported by providers.

K. Glossary

What are the Acronyms and Terminology?

(source: State of New Hampshire Broadband Action Plan, June 30, 2008, Appendix A - Glossary of Terms <http://www.nheconomy.com/uploads/Broadband-Action-Plan-Appendices.pdf>)

Backbone or Transport Layer

A backbone network or network backbone is a part of computer network infrastructure that interconnects various pieces of network, providing a path for the exchange of information between different LANs or subnetworks. A backbone can tie together diverse networks in the same building, in different buildings in a campus environment, or over wide areas. Normally, the backbone's capacity is greater than the networks connected to it.

A large corporation that has many locations may have a backbone network that ties all of the locations together, for example, if a server cluster needs to be accessed by different departments of a company that are located at different geographical locations. The pieces of the network connections (for example: ethernet, wireless) that bring these departments together is often mentioned as network backbone. Network congestion is often taken into consideration while designing backbones.

Backbone networks should not be confused with the Internet backbone. (source: http://en.wikipedia.org/wiki/Backbone_network)

The Internet backbone refers to the principal data routes between large, strategically interconnected networks and core routers in the Internet. These data routes are hosted by commercial, government, academic and other high-capacity network centers, the Internet exchange points and network access points that interchange Internet traffic between the countries, continents and across the oceans of the world. Internet service providers (often Tier 1 networks) participate in Internet backbone exchange traffic by privately negotiated interconnection agreements, primarily governed by the principle of settlement-free peering. (source: http://en.wikipedia.org/wiki/Internet_backbone)

Bandwidth

The transmission capacity of an electronic pathway such as a communications line, computer bus or computer channel. In a digital line, it is measured in bits per second or bytes per second (see Mb/sec). In an analog channel or in a digital channel that is wrapped in a carrier frequency, bandwidth is the difference between the highest and lowest frequencies and is measured in Hertz (kHz, MHz, GHz).

Broadband

(1) High-speed transmission. The term commonly refers to Internet access via cable and DSL, which is as much as 400 times faster than analog dial-up. The term has always referred to a higher-speed connection, but the speed threshold varies with the times. Widely employed in companies, the 1.5 Mbps T1 line was often considered the starting point for broadband speeds, while the FCC defines broadband as a minimum upload speed of 200 Kbps.

The T1 line is no longer the coveted connection for Web surfing. Home users with cable modems experience download speeds up to four times that of T1 and more (see cable modem). For example, in 2007, Comcast offered home users a premium service of 1 Mbps upload and 16 Mbps download. Fiber-based offerings from telephone companies are even greater.

After the turn of the century, South Korea leapfrogged the U.S. in Internet access, offering DSL up to 50 Mbps and calling their 1.5 Mbps service "light." See broadband router, wireless broadband, T1, cable modem and DSL.

(2) Transmitting data by modulating a carrier wave in order to differentiate it from other signals in the air or in a single line. For example, frequency division multiplexing (FDM) is used to carry hundreds of channels of analog and digital TV in a single coaxial cable. In this context, broadband is used in contrast with "baseband," which is data that has not been modulated or multiplexed (see baseband and TDM). In most cases, the term "broadband" is used for high-speed transmission as in definition #1 above.

Cable modem

A modem used to connect a computer to a cable TV service that provides Internet access. Cable modems can dramatically increase the bandwidth between the user's computer and the Internet service provider. Download speeds have reached 6 Mbps and beyond, but the connection is asynchronous. In order to prevent users with lower-cost cable access from hosting high-traffic Web servers, the upload speed is considerably slower, from 10 to 20 times slower. Cable operators also routinely change IP addresses assigned to users to prevent Web hosting (see DDNS).

DSL

(Digital Subscriber Line) A technology that dramatically increases the digital capacity of ordinary telephone lines (the local loops) into the home or office. DSL speeds are based on the distance between the customer and Telco central office. There are two main categories. Asymmetric DSL (ADSL) is for Internet access, where fast downstream is required, but slow upstream is acceptable. Symmetric DSL (SDSL, HDSL, etc.) is designed for connections that require high speed in both directions.

Fiber-optic

Refers to systems that use optical fibers. Fiber- optic communications networks have transformed the world. Barely starting in the late 1960s but gaining serious momentum in the 1980s, the phone companies began to replace their copper long distance trunks with fiber cable. Eventually, all transmission systems and networks are expected to become fiber based, even to the home. In time, the electronic circuits in computers may be partially or fully replaced with circuits of light, in which case fiber pathways would be used throughout the system.

Fixed Wireless

Refers to point-to-point transmission through the air between stationary devices. Fixed wireless is typically used for "last mile" connectivity to buildings.

Kbps

One thousand bits per second. Kbps is used as a rating of relatively slow transmission speed compared to the common Mbps or Gbps ratings.

Last Mile

The connection between the customer and the telephone company, cable company or ISP. The last mile has traditionally used copper-based telephone wire or coaxial cable, but wireless technologies offer alternative options in some locations. Also called "first mile."

Mbps

Mbps means megabits per second and is used for transmission speeds in a network or in internal circuits.

Middle Mile (source: http://en.wikipedia.org/wiki/Middle_mile)

In the broadband Internet industry, the "middle mile" is the segment of a telecommunications network linking a network operator's core network to the local network plant, typically situated in the incumbent telco's central office, (British English: telephone exchange) that provides access to the local loop, or in the case of cable television operators, the local cable modem termination system. This includes both the backhaul network to the nearest aggregation point, and any other parts of the network needed to connect the aggregation point to the nearest point of presence on the operator's core network.

Middle-mile provision is a major issue in reducing the price of broadband Internet provision by non-incumbent operators. Internet bandwidth is relatively inexpensive to purchase in bulk at the major Internet peering points, and access to end-customer ports in the incumbent operator's local distribution plant (typically where

local loop unbundling is mandated by a telecom regulator are also relatively inexpensive relative to typical broadband subscription costs.

However, middle-mile access, where bought from the incumbent operator, is often much more expensive than either, and typically forms the major expensive of non-incumbent broadband ISPs. The alternative, building out their own fibre networks, is capital-intensive, and thus unavailable to most new operators. For this reason, many proposals for government broadband stimulus initiatives are directed at building out the middle mile. Two examples are the Network New Hampshire Now and Maine Fiber Company in the Northeast US, both funded largely by the National Broadband Plan (United States) to connect all community anchor institutions.

Open access initiatives such as duct sharing, utility pole sharing, and fiber unbundling are also being tried by regulators as mechanisms to ease the middle mile problem by reducing costs to non-incumbents. This sometimes leads to controversies, such as the NRECA opposition to pole attachment tariff changes [1] motivated by the US plan.

Mobile Wireless

Refers to transmission through the air from a base station to a moving device such as a cell phone.

Cellular vs. Wi-Fi

Cellular carriers offer optional, digital data services for Web browsing, e-mail and other text and data applications. The data service is separate from the carrier's voice plans, often costing considerably more than a basic voice subscription. The cell phones must support the data service, which is also available for laptops and other portable devices with the installation of the appropriate modem.

Wi-Fi networks are available to the public in many cities and municipal areas. Individual venues such as airports and coffee shops also provide service (see hotspot). Typically fee based by the hour or day, some municipalities provide free service (see Muni Wi-Fi).

Location is the key issue in real estate and also the primary concern with wireless systems. For travelers who need ubiquitous connectivity, there are many gaps (white spaces) in Wi-Fi coverage. Although cellular data rates (EDGE, EV-DO, HSPA, etc.) are typically slower than Wi-Fi, cellular carriers offer the most inclusive coverage when traveling, very often equivalent to using a cell phone for voice.

Satellite Broadband (source: <http://www.fcc.gov/guides/getting-broadband>)

Just as satellites orbiting the earth provide necessary links for telephone and television service, they can also provide links for broadband services. Satellite broadband is another form of wireless broadband and is particularly useful for serving remote or sparsely populated areas.

Downstream and upstream speeds for satellite broadband depend on several factors, including the provider and service package purchased, the consumer's line of sight to the orbiting satellite, and the weather. Satellite service can be disrupted in extreme weather conditions. Typically a consumer can expect to receive (download) at a speed of about 1 Mbps and send (upload) at a speed of about 200 kbps. These speeds may be slower than DSL and cable modem, but the download speed is still much faster than the download speed with dial-up Internet access. New facilities, scheduled for deployment in 2012, are expected to support consumer broadband services for several million customers at speeds up to 12 Mbps for downloads and 3 Mbps for uploads.

Obtaining satellite broadband can be more costly or more involved than obtaining DSL or cable modem. A user must have:

- a two or three foot dish or base station - the most costly item;
- a satellite Internet modem; and
- a clear line of sight to the provider's satellite.

To find out if satellite broadband is available to your home, contact broadband satellite companies or your state's public service commission.

Exede Exceeds Expectations

To some fanfare at the Consumer Electronics Show in January 2012, ViaSat, which bought satellite broadband provider WildBlue in 2009, unveiled its new service, Exede. With \$400 million in a new satellite, plus ground stations and terrestrial fiber networks, the company [wants to change the image](#), and the expectations associated with, satellite broadband. Not to be outdone, HughesNet Gen4 has also upped its increased speeds to 15 Mbps. While it remains to be seen whether rural America will adopt, the new satellite services provide new options for areas without access to fiber, cable or wireless broadband services. [source: <http://broadbandbreakfast.com/2012/12/the-year-in-broadband-2012-the-top-10-events/>]

How is Broadband Delivered?

"Let's take a step back and look at the basic contours of the landline U.S. telecom and cable market. In general, there are three types of wired networks that serve America's phone, cable, and Internet consumers. Copper wire (traditional phone lines, DSL, slow speeds); cable (faster speeds, mostly for downloading); and fiber (potentially unlimited speeds, data is transmitted through pulses of light). In over 75% of the country, the only broadband choice for Americans will soon be cable, according to Crawford. Consumers are fleeing their relatively slow DSL service so rapidly that 94% of new broadband subscriptions in the third-quarter of 2012 went to faster cable service." [source: <http://business.time.com/2013/01/09/is-broadband-internet-access-a-public-utility/>]

(For an alternative to the descriptions from [Connecting Communities](#) below, see [Getting Broadband](#) on the FCC web site)

There are many different types of broadband delivery technologies. Each of them delivers similar services to consumers and businesses. The broadband technologies can be separated into two categories.

- Wired broadband is delivered through some type of wire to the home or office; and
- Wireless broadband uses radio waves to deliver the service

Wired

- **Digital Subscriber Lines (DSL)**

Major providers include Verizon, SBC, Bellsouth, Qwest.

- Uses plain old phone lines (POTS)
- Voice and data over the same line
- Speed 1.5-8 Mbps (mega bits per second) and provides adequate speeds for residents and most small businesses
- Requires location near central phone office or switch (18,000 feet) - service is often unavailable in rural areas
- Phone lines are everywhere but not all of them are able to support DSL
- Direct one-on-one connection; bandwidth is not shared with neighbors
- The process of installing DSL takes longer and is potentially rockier than the process of installing cable modem access
- DSL offers options and features that are useful for businesses

- **Cable Modem**

DOCSIS 3.0

Early in the year, cable giant Comcast announced that it had [completed its DOCSIS 3.0 expansion](#) for its entire footprint in the United States. DOCSIS 3.0 is the name for the next version of cable modem technology. The move brings the possibility of promised speeds of 100 megabits per second to all of Comcast's 52 million household subscribers, although consumers need to subscribe to them. Additionally, consumers need DOCSIS 3.0 hardware in order to take the service, and [somewhere between 43 percent and 77 percent](#) of the nation's cable subscribers had that upgrade. The cable industry's push for DOCSIS 3.0 stands in contrast with Verizon's decision to stop the expansion of its Fiber Optic Service and AT&T's November 7, 2012, announcement that it will begin to [favor investments in wireless technology over uVerse investments](#). Traditional telephone giants may be leaving the wireline field to their former cable competitors. [source: <http://broadbandbreakfast.com/2012/12/the-year-in-broadband-2012-the-top-10-events/>]

Major providers include AT&T, Comcast, Cox, Time Warner. ISP's that use the pipes of the major cable companies also offer services - e.g. AOL, MSN.

- Faster than DSL
- Uses the same cable television lines that deliver pictures and sound to your TV set
- Shared connection - speeds can slow down when many people in the same neighborhood are online
- Easy to install - Since it's a relatively mature technology, installing the service doesn't typically require a long wait and the installation process is smooth and simple
- It's easy to determine whether the service is available in your area

- Coverage areas are mostly residential, so businesses often can't get the service
- **Leased Lines (T1)**

A 1.544 Mbps point-to-point dedicated, digital circuit provided by the telephone companies. The monthly cost is typically based on distance. T1 lines are widely used for private networks as well as interconnections between an organization's PBX or LAN and the Telco. The first T1 line was tariffed by AT&T in January 1983. However, starting in the early 1960s, T1 was deployed in intercity trunks by AT&T to improve signal quality and make more efficient use of the network. (source: State of New Hampshire Broadband Action Plan, June 30, 2008, Appendix A - Glossary of Terms <http://www.nheconomy.com/uploads/Broadband-Action-Plan-Appendices.pdf>)
- **Fiber Optic Cable**

Fiber cable can deliver extremely high bandwidths. Several phone companies are building fiber to the home networks in densely populated communities where they can justify the high cost of building out the network. Some rural communities including Saint Peter, MN and Columbus, KS are served by fiber to the home. Rural Pickens County, GA worked with a local cable company to build a fiber ring to serve the schools and industrial parks in the county.

 - Delivered over fiber optic cables
 - Very high bandwidth
 - High cost to build fiber network
 - Low maintenance
- **Broadband Over Powerline (BPL)**

BPL delivers broadband over the power lines. It is being piloted in several communities. Financial analysis of these pilots indicate each transformer needs to serve 4-6 homes to deliver the service at prices comparable to DSL or Cable. Manassas Virginia is the first City in the nation to offer broadband internet service through the power lines (BPL). Users will be able to access the internet by plugging a modem into any electrical outlet in the City, whether it is from room to room or in an office across town. Business owners will enjoy the ease, flexibility, and portability that internet delivery through the power lines offers. It costs approximately \$29 per month for residential use. The provider (COMTek) expects to announce that it has reached the 1000th customer milestone in Manassas during the summer of 2006.

 - Delivered through power lines
 - Almost all homes and businesses are connected to the power grid
 - Still in early stages of development
 - Potential interference with radio signals
 - Speeds similar to DSL and cable

Wireless

- **Satellite**

- Available most places, including hard-to-reach rural areas
- Satellite service is available everywhere in the U.S. It's especially popular with people who want high-speed service but can't get DSL or cable modem access in their areas
- Slower than cable or DSL. WildBlue download speeds up to 1.5 Mbps and upload speeds up to 256 Kbps.
- Trees and heavy rain affects signal
- Need unobstructed view of southern sky
- Professional installation is required by the FCC
- Though it's still considered high-speed service, satellite speeds are slower than cable or DSL, and users sometimes experience downtime

- **Fixed Wireless Networks**

Fixed wireless networks serve many rural communities where phone or cable companies aren't delivering broadband. Wireless networks can be installed quickly and are relatively inexpensive to deploy. Some local governments are installing wireless, but more commonly a private WISP (Wireless Internet Service Provider) delivers the service. Wireless broadband delivered to a home or business location is called fixed wireless. Mobile wireless service is becoming common. Wireless can deliver broadband at speeds equivalent to DSL and cable at comparable or a little higher cost. It can also be configured to deliver higher speeds required by some businesses. There are many different types of wireless networks.

- **Point-to-Point Fixed Wireless**

Uses part of the radio spectrum to send and receive signals.

Typically made up of on-the-ground antenna-to-antenna systems.

- Requires indoor or outdoor antenna on the home
- Coverage is about 5 miles from the transmitter or access point
- High bandwidth
- Usually licensed
- Backbone or transport layer
- Line of site

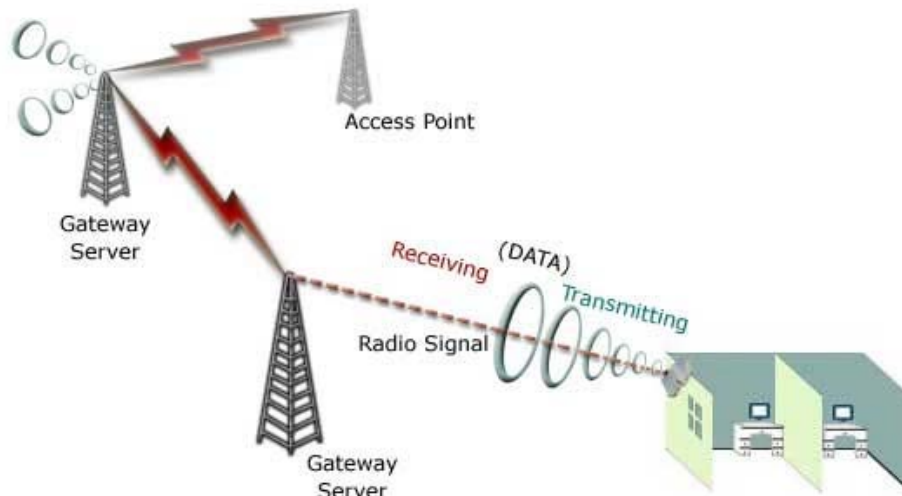

○ **Point-to-Multipoint Fixed Wireless**

Point to multi-point refers to the portion of a wireless network that delivers the service to a user. A radio in the network transmits and receives signals from an antenna (CPU - Customer Premise Unit) at the home or business. Although the signal can be delivered over long distances from the tower, the CPU needs to have a clear line of sight to the tower. The line of sight requirements causes problems in hilly terrain and tree leaves interfere with the signal.

- Broadband delivery to premise
- Consumer or business grade
- One antenna to many sites
- Line-of-sight
- Large coverage area
- Licensed or unlicensed

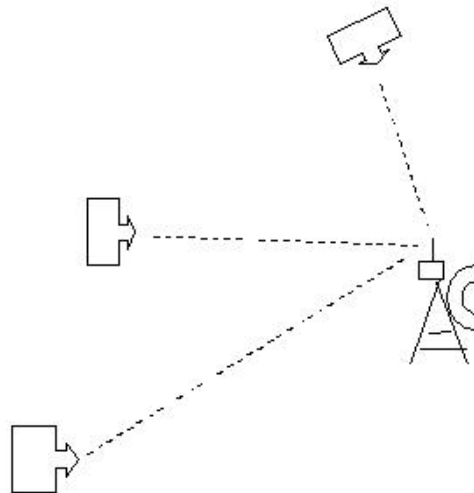

○ **Mesh Fixed Wireless**

Mesh networks are another type of broadband network that work well in downtowns. The nodes provide service over a 200-300 foot radius. Each node transmits to other nodes in the network moving the data to and from the end user.

- Nodes (radios)
 - Connect to user
 - Transmit to aggregation point
- Typically unlicensed
- Favor urban areas or hot zones

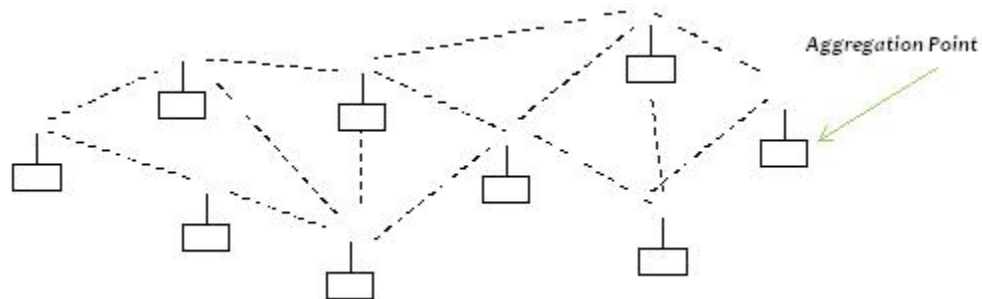

- **Wi-Fi** (Wireless Fidelity) ("Hot Zones", "Hot Spots")

Example: Antenna on a grain elevator sends a signal to local café (access point). Users within 300 feet of the café can pick up the signal. What do you need to connect to a public WiFi hot spot? A laptop and a WiFi card (PCMCIA Wireless Network Card). A WiFi card costs about \$50.

- Wi-Fi access points found at cafés, homes, campuses, businesses
- Access is limited to 50-300 feet
- Coverage limited by location and number of transmitters
- Relatively cheap for providers to set-up
- End-user equipment cheap and easy to install
- **WiMAX**
 - Wi-Fi on steroids
 - Can cover a large area 30 miles
 - Still in early stages of development
 - Can support ultra-broadband, a large pipe with lots of bandwidth and speed - just what you would need to run your own real-time online video channel.
- **Mobile Wireless Service (Cell, G3,G4)**

[Third generation \(3G\) and fourth generation \(4G\)](#) mobile wireless technologies allow consumers to access a variety of different mobile services and functionalities, such as web browsing, e-mail, access to application ("app") stores, video conference or chat, mapping and navigation systems, mobile commerce, and the downloading of content. A range of different mobile devices include built-in 3G or 4G wireless connectivity, including smartphones, tablets, e-readers, and netbook and laptop computers. Several mobile network technologies are generally considered to be 3G or 4G, including EV-DO, WCDMA, HSPA, HSPA+, LTE, and mobile WiMAX. (source: <http://www.fcc.gov/topic/3g-4g-wireless>)
- **WISP**

A wireless Internet service provider (WISP) is an Internet service provider with a network based on wireless networking. Technology may include commonplace Wi-Fi wireless mesh networking, or proprietary equipment designed to operate over open 900 MHz, 2.4 GHz, 4.9, 5.2, 5.4, 5.7, and 5.8 GHz bands or licensed frequencies in the UHF band (including the MMDS frequency band). (source: http://en.wikipedia.org/wiki/Wireless_Internet_Service_Provider)

How Much Does Broadband Cost?

It depends on . . .

- How fast you want to go
- Residential or business use
- Pricing of the provider

DSL and high-speed wireless business rates can range from \$30 to \$100 per month at speeds from 128 kbps to 3 Mbps upstream and 3-6 Mbps downstream. 2-way satellite ranges from \$70-80 per month. Cable broadband is normally "bundled" with voice and video services at prices comparable to DSL. Many customers initially subscribe at a lower speed and move upward as their need for speed increases. Businesses may pay more for their connections due to guaranteed quality of service agreements.

The good news about the cost of broadband:

- A broadband connection does not require a second phone line (which you will have to pay for in addition to your dial-up service).
- A broadband connection almost always includes a wide range of ISP services (e.g., content, multiple e-mail addresses, hosting, storage, etc.), whereas with dial-up, these often cost extra.
- A broadband connection is "all you can eat"; whereas some dial up connections still restrict usage to a monthly allotment of minutes.

(Source:

http://srdc.msstate.edu/ecommerce/curricula/connectingcommunities/files/3_1typesofbroadband.ppt)